

The Islamic University of Gaza
Graduate Studies - Faculty of Engineering
Electrical Engineering Department



Characterization of Radio Over Fiber Employed GPON Architecture for Different Modulation Schemes

توصيف تقنية الراديو عبر الألياف الضوئية باستخدام عمارة شبكات
الجيجا بت الضوئية السالبة GPON لأنواع التضمين المختلفة

A Thesis Presented by:

Yehia Omar Urouq

Under Supervision of:

Dr. Fady El-Nahal

A Thesis Submitted in Partial Fulfillment of the Requirements for the
Degree of Master in Electrical Engineering/Communication Systems

April , 2014

إقرار

أنا الموقع أدناه مقدم الرسالة التي تحمل العنوان:

Characterization of Radio Over Fiber Employed GPON Architecture for Different Modulation Schemes

أقر بأن ما اشتملت عليه هذه الرسالة إنما هو نتاج جهدي الخاص، باستثناء ما تمت الإشارة إليه حيثما ورد، وإن هذه الرسالة ككل أو أي جزء منها لم يقدم من قبل لنيل درجة أو لقب علمي أو بحثي لدى أي مؤسسة تعليمية أو بحثية أخرى.

DECLARATION

The work provided in this thesis, unless otherwise referenced, is the researcher's own work, and has not been submitted elsewhere for any other degree or qualification

Student's name:

اسم الطالب: يحيى عمر محمود عروق

Signature:

التوقيع: 

Date:

التاريخ: 2014 / 05 / 19



نتيجة الحكم على أطروحة ماجستير

بناءً على موافقة شئون البحث العلمي والدراسات العليا بالجامعة الإسلامية بغزة على تشكيل لجنة الحكم على أطروحة الباحث/ يحيى عمر محمود عروق لنيل درجة الماجستير في كلية الهندسة قسم الهندسة الكهربائية - أنظمة الاتصالات وموضوعها:

توصيف تقنية الراديو عبر الألياف الضوئية باستخدام عمارة شبكات الجيجابت الضوئية

السالبة "GPON" لأنواع التضمين المختلفة

Characterization of Radio Over Fiber Employed GPON Architecture for Different Modulation Schemes

وبعد المناقشة التي تمت اليوم الأحد 05 رجب 1435هـ، الموافق 2014/05/04م الساعة العاشرة صباحاً، اجتمعت لجنة الحكم على الأطروحة والمكونة من:

.....
.....
.....

مشرفاً ورئيساً

د. فادي إبراهيم النحال

مناقشاً داخلياً

د. طلال فايز سكيك

مناقشاً خارجياً

د. عبد الحكيم محمد حسين

وبعد المداولة أوصت اللجنة بمنح الباحث درجة الماجستير في كلية الهندسة / قسم الهندسة الكهربائية -

أنظمة الاتصالات.

واللجنة إذ تمنحه هذه الدرجة فإنها توصيه بتقوى الله ولزوم طاعته وأن يسخر علمه في خدمة دينه ووطنه.

والله ولي التوفيق،،،

مساعد نائب الرئيس للبحث العلمي والدراسات العليا

.....

أ.د. فؤاد علي العاجز



Abstract

One of the most significant developments within the fiber optic technology is passive optical network (PON) which is a point-to-multipoint network architecture. Compare to other PONs, Gigabit-PON (GPON) is attractive due to the flexibility, simple and low cost passive connection. Radio over fiber (RoF) is One of the most important applications in the fiber optic system, RoF is a hybrid system that integrates the wireless and optical in one system. The combination of GPON with RoF technology provides high capacity, high data rate and low cost of development. This research provides characterization of RoF employed GPON architecture for wireless distribution network. The Simulations has been performed on OPTISYSTEM software. The analysis of simulation results are based on the bit error rate (BER), received signal strength and eye pattern obtained for various modulation schemes. The system has been analyzed using phase shift keying (PSK) modulation, differential phase shift keying (DPSK) modulation and offset quadrature phase shift keying (OQPSK) modulation with different length from the optical line termination (OLT) to optical network unit (ONU). The best results were achieved using PSK modulation, and for different modulation schemes, the BER is accepted for length of fiber up to 40 km in upstream and downstream.

ملخص الرسالة

من ابرز معالم التطوير في تقنية الالياف الضوئية ظهور الشبكات الضوئية السالبة القائمة على نظام ارسال النقطة لأكثر من نقطة. بالمقارنة مع الشبكات الضوئية السالبة لأخرى فان شبكات الجيجا بت الضوئية السالبة GPON اكتسبت الكثير من الاهتمام بسبب المرونة والبساطة وقلة تكلفة التوصيل السالب. الراديو عبر الألياف الضوئية (ROF) هي واحدة من أهم التطبيقات في نظام الألياف البصرية، ROF هو نظام هجين يدمج اللاسلكية والبصرية في نظام واحد. المزج بين شبكات الجيجا بت الضوئية السالبة وبين تقنية ROF يوفر سعة عالية، معدل نقل عالي للبيانات وتكلفة منخفضة للتنمية. هذا البحث يقدم توصيف لتقنية الراديو عبر الألياف الضوئية باستخدام عمارة شبكات الجيجا بت الضوئية السالبة لاستخدام شبكة التوزيع اللاسلكي. تم إجراء المحاكاة عن طريق برنامج. OPTISYSTEM, التحليل لنتائج المحاكاة اعتمد على منحني نسبة الخطأ، قوة الإشارة وتلقى نمط العين التي تم الحصول عليها عن مخططات التضمين المختلفة. تم تحليل النظام باستخدام انواع التضمين التالية، PSK, DPSK and OQPSK. سوف نختبر أداء النظام لمسافات مختلفة بين نقطة انهاء الخط البصري OLT ونقطة وحدة الشبكة البصرية ONU. النظام أعطى أفضل نتائج باستخدام طريقة التضمين PSK ، أيضا منحني نسبة الخطأ أعطى نتائج مقبولة لجميع أنواع التضمين وحتى طول 40 كم للألياف الضوئية في كل من مرحلة التنزيل ومرحلة الإرسال.

Acknowledgement

A thesis cannot be completed without the help of many people who contribute directly or indirectly through their constructive criticism in the evolution and presentation of this work.

I would like to express my deepest gratitude for my parents who have always been there to support me. I also thank my wife who has been strongly supportive to me to the end of this thesis.

I am also greatly thankful to my supervisor, Dr. Fady El-Nahal, whose encouragement, guidance and support from the initial to the final phase enabled me to develop a deep and thorough understanding of the subject. Finally, I offer my regards and blessings to all of those who supported me in any respect during the completion of the thesis.

Table of Contents

Abstract	II
ملخص الرسالة	III
Acknowledgement	IV
Table of Contents	V
List of Figures	VII
List of Tables	IX
Abbreviations	X
Chapter 1 – Introduction	1
1.1 Introduction	1
1.2 Problem Statement	2
1.3 Literature Review	2
1.4 Objectives	3
1.5 Thesis Overview	4
Chapter 2 - Optical Communications and Passive Optical Network	5
2.1 Introduction	5
2.2 Optical Transmission link	5
2.2.1 Optical Transmitter	6
2.2.1.1 Light Emitting Diodes	6
2.2.1.2 Laser Diodes	6
2.2.2 Fiber	6
2.2.2.1 Multimode versus Single mode Fiber	7
2.2.2.2 Fiber Attenuation	8
2.2.2.3 Dispersion	8
2.2.3 Optical Receivers	9
2.2.3.1 PIN Receivers	10
2.2.3.2 Avalanche Photodiode Receivers	10
2.2.4 Optical Modulation	11
2.2.4.1 Electro-optic Modulation System	12
2.2.4.2 Electro-optic Match Zender Modulation	12
2.2.5 Optical Amplifier	12
2.2.5.1 Erbium doped Fiber Amplifier EDFA	14
2.3 Passive Optical Networks	14
2.3.1 Generic Operation of passive Optical Networks	15

2.3.2 Optical Line Terminal	15
2.3.3 Optical Network Unit ONU	16
2.3.4 Splitter	16
2.3.5 Operation Description Of Passive Optical Networks	17
2.3.5.1 Downstream Channel	17
2.3.5.2 Upstream Channel	17
2.3.6 GPON	17
2.3.8 Why GPON	19
Chapter 3 Radio Over Fiber RoF	20
3.1 Introduction	20
3.2 RoF Link Configuration	21
3.3 Benefits of RoF Technology	22
3.3.1 Low Attenuation	22
3.3.2 Large BandWidth	23
3.3.3 Immunity to Radios Frequency Interference	23
3.3.4 Dynamic Resource Allocation	23
3.3.5 Low Cost	24
3.4 Application of Rof Technology	24
3.4.1 Cellular Networks	24
3.4.2 Satellite Communications	24
3.4.3 Wireless LAN	25
3.4.4 vehicle communication and control	25
3.5 Digital modulation.....	25
3.5.1 Phase Shift Keying (PSK).....	26
3.5.2 Quadrature phase-shift keying (QPSK)	26
3.5.3 Differential Phase shift keying (DPSK)	27
Chapter 4 Design Of The RoF Employed GPON Architecture	28
4.1 Introduction	28
4.2 System Model of Bidirectional Transmission for RoF employed GPON Architecture	29
4.2.1 Downstream Link	32
4.2.1.1 Transmitter	33
4.2.1.2 Circulator	34
4.2.1.3 Fiber	35
4.2.1.4 Splitter	35

4.2.1.5 Receiver	36
4.2.2 Upstream Link	37
4.2.2.1 Transmitter	37
4.2.2.2 Splitter, Fiber and Circulator	41
4.2.2.3 Receiver	41
4.3 Results for PSK Modulation for 20 Km Fiber Length	42
4.4 Results for DPSK Modulation for 20 Km Fiber Length	45
4.5 Results for OQPSK Modulation for 20 Km Fiber Length	47
4.6 Test the performance of the PSK, DPSK and QPSK System for different Fiber length	49
4.6 Results comparison of various modulation type and fiber link	52
4.7 summary	55
Chapter 5 Conclusion and Future Work	56
5.1 summary	56
5.2 Suggestion for Improvement	57
References	58

List Of Figures

Figure 2.1 : Optical transmission link.	5
Figure 2.2 : Optical fiber core with surrounding cladding and protective jacket	7
Figure 2.3: PIN photodetector.....	10
Figure 2.4: Functional types of optical	13
Figure 2.5 : Passive Optical Networking Diagram.	15
Figure 2.6: ITU-T GPON Standard G.984: Single Fiber.	18
Figure 3.1: General RoF Architecture	21
Figure 3.2 Radio signal transport schemes for RoF systems	22
Figure 3.3:Constellation diagram for BPSK.....	26
Figure 3.4: Constellation diagram for QPSK.....	27
Figure 4.1 Schematic of a bidirectional RoF system	29
Figure 4.2: System model in optisystem.....	30
Figure 4.3 Transmitter in the bidirectional RoF system	31
Figure 4.4 Receiver in the bidirectional RoF system	31
Figure 4.5 PSK Modulated signal	33
Figure 4.6 modulation at the MZM	34
Figure 4.7: The electrical signal after PIN.	36
Figure 4.8 The MZM transmitted signal at 1330 nm.	38
Figure 4.9: implementation of TDMA using two cascaded dynamic Y selector...	39
Figure 4.10 Signal transmitted by ONU 1 in time domain	40
Figure 4.11 Signal transmitted by ONU 16 in time domain	40
Figure 4.12 Signal transmitted by ONU 32 in time domain	41

figure 4.13 Splitter output toward the fiber in the time domain	41
Figure 4.14: Receiver in upstream	42
Figure 4.15: received signal after photo detection and filtering.	42
Figure 4.16: RF spectrum regenerated at the 5GHz working frequency.	43
Figure 4.17: Eye diagram and BER of ONU 1 – downstream.	43
Figure 4.18: Eye diagram and BER for upstream.	44
Figure 4.19: RF spectrum regenerated at the 5GHz working frequency.	45
Figure 4.20: DPSK Eye diagram and BER for downstream.	46
Figure 4.21 : DPSK Eye diagram and BER for upstream.	46
Figure 4.22 : RF spectrum regenerated at the 5GHz working frequency.	47
Figure 4.23: OQPSK Eye diagram and BER for downstream.	48
Figure 4.24: OQPSK Eye diagram and BER for upstream.	48
Figure 4.25: BER of PSK for system of varied fiber length.	49
Figure 4.26: Received Power for PSK system of varied fiber length.	50
Figure 4.27 BER of DPSK for system of varied fiber length.	50
Figure 4.28: Received Power for DPSK system of varied fiber length.	51
Figure 4.29: BER of OQPSK for system of varied fiber length.	51
Figure 4.30: Received Power for OQPSK system of varied fiber length.	52
Figure 4.31: downstream BER for PSK,OQPSK and DPSK and for varied fiber length.	53
Figure 4.32 Upstream BER for PSK,OQPSK and DPSK and for varied fiber length.	53

List Of Tables

Table 4.1 hardware configurations of the transmitter in Downstream .	34
Table 4.2 hardware configurations of the fiber	35
Table 4.3 hardware configurations of the Splitter	36
Table 4.4 hardware configurations of the Receiver	37
Table 4.5 hardware configurations of the transmitter in Upstream	38
Table 4.6 PSK downstream – upstream results	44
Table 4.7 DPSK downstream – upstream results	47
Table 4.8 OQPSK downstream – upstream results	49
Table 4.9 Results comparison for various modulation type and fiber link	54

Abbreviations

APD	Avalanche Photodiode
ASE	Amplified Spontaneously Emission
ATM	Asynchronous Transfer Mode
BB	Baseband
BER	Bit Error Rate
BPF	Band Pass Filter
BPON	Broadband Passive Optical Network
BS	Base Station
BW	BandWidth
CS	Central Station
CW	Continuous Wave
dB	Decibels
DPSK	Differential Phase Shift Keying
DWDM	Dense Wavelength Division Multiplexing
EDFA	Erbium-doped fiber Amplifiers
EFM	Ethernet in the First Mile
EMI	Electro-Magnetic Interference
EPON	Ethernet Passive Optical Network
FOA	Fiber Optical Amplifiers
FSAN	Full Service Access Network
FTTH	Fiber-to-the-Home
GPON	Gigabit Passive Optical Network
GSM	Global System for Mobile Communications
HDTV	High-definition television
IEEE	Institute of Electrical and Electronics Engineers

IF	Intermediate Frequency
ISI	Intersymbol Interference
ITS	Intelligent Transport Systems
ITU	International Telecommunication Union
IVC	Inter-Vehicle Communication
LD	Laser Diode
LED	Light Emitting Diode
MAC	Media Access Control
MZM	Mach-Zehnder Modulator
NT	Network Terminal
ODN	Optical Distribution Network
OQPSK	Offset Quadrature Phase Shift Keying
OLT	Optical Line Terminal
ONU	Optical Network Unit
OTL	Optical Transmission Link
OTDM	Optical Time Division Multiplexing
PIN	Positive-Intrinsic-Negative
PM	Physical Media
PMD	Polarization Mode Dispersion
POF	Polymer Optical Fibers
POLT	Packet Optical Line Terminal
PON	Passive Optical Network
PRBS	Pseudo Random Binary Sequence
PSK	Phase Shift Keying
QPSK	Quadrature Phase Shift Keying
RBS	Remote Base Station

RF	Radio Frequency
RoF	Radio over Fiber
RS	Remote Station
RVC	Road-to-Vehicle Communication
SMF	Single Mode Fiber
SOA	Semiconductor Optical Amplifier
TDM	Time Division Multiple
TDMA	Time Division Multiple Access
VOLT	Video Optical Line Terminal
WDM	Wavelength Division Multiplexing
WLAN	Wireless Local Area Network

This page left intentionally blank

1.1 INTRODUCTION

The result of integrated fiber optic and wireless is considered the base for the convergence of radio and optical system. Thus, an efficient technology is needed to appropriately support the operation of this advanced system. By making broadband access network termination close to the end users, it is now easily to use new application with high Band Width (BW) demand such as high definition video services. Thus, the proposed solution is Passive Optical Network (PON) which offer more opportunities for high speed communications; also it has broadcasting features and provides better security[1].

Because of its high BW and low attenuation characteristics, Fiber optic is widely used as a major building block in the telecommunication infrastructure. The demand for and use of optical fiber has grown enormously and optical-fiber applications are widespread, ranging from global networks to desktop computers. The ability of transmitting voice, data, or video over very short, or very long distances provides remarkable value for communication networks like mobile phone, wireless system and broadband, due to the reduction of energy consumption and cost. Fiber optic technology is understood as the promising technology for future networks and trusted by users [2].

Radio over fiber (RoF) is one of the most important applications in the fiber optic system. At RoF, light modulated into radio frequency and transmits it via optical fiber to facilitate wireless access. Technically, RoF is a hybrid system that integrates the wireless and optical in one system leading towards high capacity, high data rate, transparent and mobility solution [2].

Connecting a number of Remote Base Station (RBSs) to the Central Station (CS) - centralized architecture- in RoF allows the cost reduction, easier controlling and system upgrading. RoF is a rather ideal technology for the integration of wireless and

wired networks. The main reason being is that it combines the best attributes of two common communication types. Firstly, the wireless network connection frees the end user from the constraints of a physical link to a network which is a drawback of conventional fiber optic networks. Secondly, optical networks have unlimited amount of bandwidth with which to satisfy the most bandwidth customers demand where bandwidth for wireless networks can be a considerable problem. RoF networks allow the customers to maintain their mobility while also providing them with the bandwidth necessary for both current and future communication [3].

1.2 Problem Statement

Gigabit-PON (GPON) is a variant of PON technology which can support higher data rate (~ 2.5 Gbps) using a point to multipoint access mechanism. RoF networks comes into picture when requirement of high data rate can not be satisfied by decreasing cell size or by allocating more bandwidth because both these methods lead to increased complexity of base band station. RoF system is integration of wireless and fiber based technology. The main goal of RoF system is the distribution of broadband signals to distributed base stations for wireless access using an optical access network. The combination of GPON with RoF technology provides high capacity and high data rate solution. This research provides characterization of RoF employed GPON Architecture for wireless distribution network by PSK, DPSK and OQPSK modulation. The system will be tested for length from the OLT to ONU of 10 Km up to 60Km .

1.3 Literature Review

To meet the accelerating demands in communication systems, the integration of optical network and wireless radio is a promising solution. ROF means the optical signal is being modulated at radio frequencies and transmitted via the optical fiber. In addition with broadband passive optical network BPON, GPON is the most often type used by European and US providers while providers in Asia predominantly use Ethernet passive optical network (EPON) [4].

GPON is more advantageous, more robust, offers more capacity and has higher profitability compared to EPON is the result of a comparison between EPON and

GPON [5]. An overview of Gigabit PON and analyses network architecture, transmission mechanisms and power budget in GPON systems were done successfully in [6]. The works on the distribution of the mobile 3G on GPON, have been done with limited number of ONU due to the Universal Mobile Telecommunication System (UMTS) channel limitation[7,8].

The integration of wireline and wireless services has been proposed but only concentrating on a single network connection. Good BER (10^{-13}) was achieved with fiber length extended to 45 km. However, the power budget performance was less analyzed [9]. Downstream link is presented for GPON with data rate of 1.25 Gb/s, and all the optical distribution network (ODN) classes are implemented, using Optisystem, to investigate the transmission capability and performance of the proposed downstream physical media (PM) GPON model. Some of the design constraints involved in an optical network design such as fiber span analysis, power budget and margin calculations are taken into consideration with worst case [10].

The Performance of IEEE 802.11 over fiber at Media Access Control "MAC" layer employing GPON architecture are analyzed [1]. This work presents the analysis of the adoption of fiber with GPON architecture into the wireless network which is feasible to be developed into a building. Authors measure the performance of IEEE 802.11 throughput at the MAC layer. The distribution of IEEE 802.11 Wireless Local Area Network (WLAN) service using RoF technique in GPON network architecture was characterized by means of simulation which was done in OptiSystem software [2]. The bidirectional transmission was used with fiber length varied from 2-20 km and PSK Modulation. Based on those previous papers and studies, there are so many researches and works in the field of RoF Employed GPON Architecture for Wireless Distribution Network

1.4 Objectives

- Development of the bidirectional transmission for RoF employed GPON architecture for a length from the OLT to ONU of 20 km.

- Evaluating the performance of the system using BER, Q factor and eye diagram for the PSK Modulation.
- Evaluating the performance of the system for DPSK modulation.
- Evaluating the performance of the system for OQPSK modulation.
- Evaluating the performance of the system for the different modulation schemes and different modulation schemes.
- Compare the results for the system performance for the different modulation schemes and different fiber length.

1.5 Thesis Overview

Chapter 2 shows an introduction to optical communications. The major components of a communications system are described including optical transmitters, fiber, and receivers. Following this, the concept of a PON will be presented including PON architecture which consist of the optical line terminal (OLT) at the service provider's central office (CO), the optical network units (ONUs) and the Splitter. Then PON technologies and the current standard for Gigabit-capable Passive Optical Networks (GPON) are outlined.

Chapter.3 describes the RoF technology, which shows introduction to the RoF, the benefits, the limitations and applications of RoF technology in communication fields. In addition it covers various types of modulations schemes.

Chapter 4 presents the methodological processes by showing detailed diagram of the methods implemented as well as highlighting briefly the steps those have been followed to achieve the objective of this project.

In Chapter 5 introduces the conclusions of the research, and describes the possible future works.

2.1 Introduction

Optical fiber is a transmission medium usually used in data networks, like PON. Fiber may be defined by a thin, transparent and flexible glass or plastic, by which light pulses are sent in order to represent data to be transmitted. The beam is completely contained and it spreads inside the fiber at an angle of reflection above the critical angle of total reflection, according to Snell's law [11].

Optical fiber is widely used in telecommunications because it allows to send large amounts of data to large distance and have higher bandwidths than other forms of communication. It is a transmission medium that provides high immunity to electromagnetic interference and signals travel along them without high losses. This way of transmission allows the transport of a large amounts of information. It is used for applications such as broadband internet, telephone and cable television [11]. This chapter highlights the literature cited on the optical transmission link with more details about optical fiber, optical transmitter, optical modulation, optical receiver and optical amplifier, and covers about the Passive optical Network.

2.2 Optical Transmission Link (OTL)

A general optical transmission link, is briefly described for which assumed that a digital pulse signal is transmitted over optical fiber unless otherwise specified as shown in figure 2.1. The optical link consists of an optical fiber transmitter, receiver, and amplifier each of which is dealt with in the subsequent subsections.

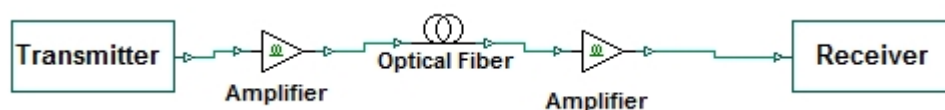

Figure 2.1: Optical transmission link.

2.2.1 Optical Transmitters

An optical transmitter converts an electrical signal into an optical signal and launches the optical signal into an optical fiber. In optical communications networks the ideal optical transmitter is one which outputs a high quality of light. This can be defined by having a narrow spectral width, high stability, low power consumption and a tunable central wavelength. The most common light sources found in fiber optic communication systems are light emitting diodes (LEDs) and laser diodes (LDs). Both are small semiconductor devices that convert electrical signals into light[11].

2.2.1.1 Light Emitting Diodes (LEDs)

LEDs emit light through spontaneous emission and are used extensively in fiber optic communication systems due to their small size, long lifetime and low cost. They are mostly found in short distance, low bandwidth networks such as local area network (LAN) as they are limited in their transmission capabilities by their low output intensity, poor beam focus and incoherent radiation[11].

2.2.1.2 Laser Diodes (LDs)

In comparison to LEDs, lasers emit light through amplification of radiation by stimulated emission. Lasers have a higher output power than LEDs and so they are capable of transmitting information over longer distances. Also lasers have a much narrower spectral width and can provide high bandwidth communication over long distances, thus are an excellent light source for long haul fiber optics links[11].

2.2.2 Fiber

Optical fiber is a dielectric waveguide that operates at optical frequencies and transmits information in the light form along its axis as shown in figure 2.2 [11]. It has a central core in which the light is guided, embedded in an outer cladding of slightly lower refractive index. Core and cladding are protected by buffer and outer jacket where the core has the highest refractive index. Optical fiber has two low-attenuation regions [12]. The region of 1300 nm is a range of 200 nm and its attenuation is less than 0.5dB/ km, has a total BW of about 25 THz. The second region centered at 1550 nm with attenuation is less than 0.2 dB/km. Combining these two regions provide a theoretical of 50 THz bandwidth. By using these large low attenuation areas for data transmission, the signal loss for a set of one or more

wavelengths can be made very small. Thus, reducing the number of amplifiers and repeaters actually needed.

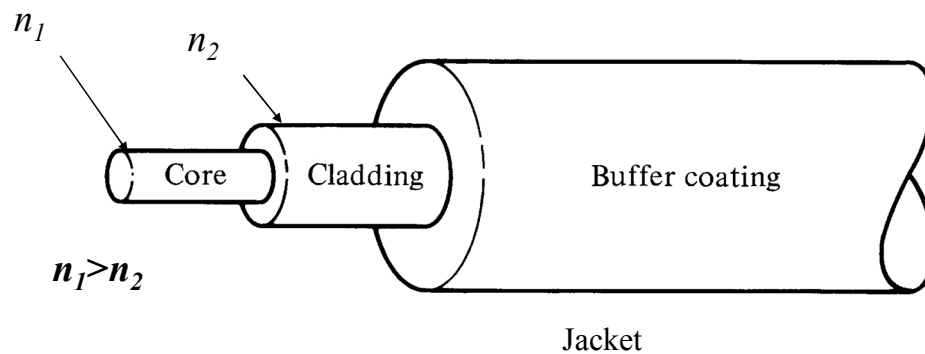

Figure 2.2: Optical fiber core with surrounding cladding and protective jacket[11]

In the experiments of long distance, optical signals can be sent over hundreds of kilometers without amplification. In addition to large bandwidth and low attenuation, Fiber offers low error rates. Communication systems using an optical fiber typically operate at BER's of less than 10^{-10} [2]. When installing local networks in buildings, the small radius of fiber make it occupy the same physical space as copper. Also, fiber transmission has high immunity to electromagnetic interference and does not cause interference. mainly there are two types of optical fiber: first so called as step index fiber and second graded-index fiber.

2.2.2.1 Multimode versus Single-Mode Fiber

A mode in an optical fiber corresponds to one of the possible multiple ways in which a wave may propagate through the fiber. It can also be viewed as a standing wave in the transverse plane of the fiber. More formally, a mode corresponds to a solution of the wave equation that is derived from Maxwell's equations and subject to boundary conditions imposed by the optical fiber waveguide. If more than one mode propagates through a fiber, then the fiber is called multimode. In general, a larger core diameter or high operating frequency allows a greater number of modes to propagate [11].

The advantage of multimode fiber is that, its core diameter is relatively large; as a result, injection of light into the fiber with low coupling loss can be accomplished by using inexpensive, large-area light sources, such as light-emitting diodes (LED's). The disadvantage of multimode fiber is that it introduces the phenomenon of intermodal

dispersion. In multimode fiber, each mode propagates at a different velocity due to different angles of incidence at the core-cladding boundary. This effect causes different rays of light from the same source to arrive at the other end of the fiber at different times, resulting in a pulse that is spread out in the time domain. Intermodal dispersion increases with the distance of propagation, so that it limits the bit rate of the transmitted signal and the distance that the signal can travel [13].

Thus, in RoF networks multimode fiber is not utilized as much as possible, instead, single-mode fiber is widely used. Single-mode fiber allows only one mode and usually has a core size of about $10\mu\text{m}$, while multimode fiber typically has a core size of $50\text{-}100\ \mu\text{m}$. It eliminates intermodal dispersion and hence can support transmission over much longer distances. However, it introduces the problem of concentrating enough power into a very small core. LED's cannot couple enough light into a single-mode fiber to facilitate long distance communications. Such a high concentration of light energy may be provided by a semiconductor laser, which can generate a narrow beam of light [11].

2.2.2.2 Fiber Attenuation

Attenuation is the loss of optical power of a signal as it travels down a fiber. Attenuation depends on the wavelength of the light propagating within it and is measured in decibels per length (dB/m, dB/km). Attenuation characteristics can be classified as intrinsic or extrinsic. Intrinsic attenuation occurs due to substances inherently present in the fiber, whereas extrinsic attenuation occurs due to external influences such as bending or connection loss [11].

2.2.2.3 Dispersion

The output from an optical communications source (LED or LASER) is not a single wavelength but in fact a distribution of wavelengths. These various wavelength components propagate along the fiber at different speeds and arrive at the receiver at different times thus causing the pulse to spread or disperse. This is characterized by the dispersion parameter [13].

Dispersion is measured in picoseconds of pulse widening per nanometer of the signal spectral width per kilometer of the path length i.e. ps/nm.km. When a pulse spreads to the degree where it overlaps with an adjacent pulse, it causes detection problems at the receiver resulting in errors in transmission. This is called intersymbol interference

(ISI) or patterning. Dispersion is a limiting factor in fiber bandwidth, as the shorter the pulses, the shorter the possible time between the pulses, the more susceptible they are to patterning [11].

There are three types of dispersion found in fiber optical communications: chromatic, intermodal and polarization mode dispersion. Chromatic dispersion occurs in all types of fibers; intermodal dispersion only occurs in multimode fibers and polarization mode dispersion is only significant in single mode fibers. Intermodal dispersion is caused when multiple modes of the same signal propagate at different velocities along the fiber. Intermodal dispersion does not occur in a single mode fiber [13].

Another form of dispersion is material or chromatic dispersion. In a dispersive medium, the index of refraction is a function of the wavelength. Thus, if the transmitted signal consists of more than one wavelength, certain wavelengths will propagate faster than other wavelengths. Since no laser can create a signal consisting of an exact single wavelength, chromatic dispersion will occur in most systems [11].

The third type of dispersion found in fibers is called polarization mode dispersion (PMD). The fundamental mode which travels in a single mode fiber has two polarization components. Ideally these two states carry half of the total power each and when the fiber is symmetric PMD is not an issue in the signal transmission [13]. PMD is caused when the fiber's cross section is not symmetric i.e. the refractive indices along the fiber's x and y axes are not equal, which leads to the broadening of the optical signal. This generally occurs during fiber-cabling and fiber-splicing processes. In early installed fibers PMD was found to severely limit the propagation distance at high bit rates [14]. Research into PMD continues as there exists a great deal of installed standard fiber which has a comparatively large PMD value which is a potential problem at high bit rates.

2.2.3 Optical Receivers

An optical receiver or detector is an electro-optical device that accepts optical signals and converts them into electrical signals. An ideal optical receiver in an optical communications system will have high sensitivity, large bandwidth, low temperature sensitivity, low power consumption and polarization independence. The most common optical receivers found in fiber optic communication systems are positive-

intrinsic-negative (PIN) photodiodes and avalanche photodiode (APD) receivers. Both are highly sensitive semiconductor devices that convert light pulses into electrical signals [11].

2.2.3.1 PIN Receivers

A positive-intrinsic-negative PIN photodiode consists of a thick intrinsic (undoped) depletion region sandwiched between positive and negative doped regions as shown in Figure 2.3. The material of the p and n layers is chosen so that there is no absorption of the incident photons in these layers. It is generally operated by applying a reverse-bias voltage, typically less than a few volts. Most of the incident photons will enter the thick intrinsic layer and produce electron-hole pairs which will generate a photocurrent. This photocurrent is in direct proportion to the absorbed optical power [15].

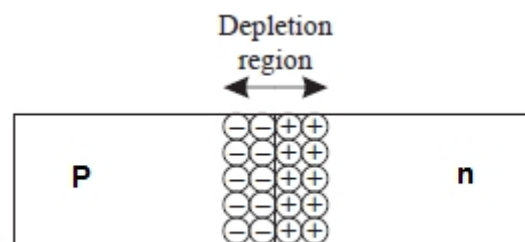

Figure 2.3: PIN photodetector[15]

A current known as dark current is still produced by the leakage current that flows when the reverse bias is applied without any incident light on the photodiode. Dark current is temperature dependent and will increase as the device temperature increases. The PIN photodiode allows high bandwidths and responsivity to be achieved simultaneously [16]. PIN photodiodes are the most commonly employed receivers in fiber optic communication systems due to their ease in fabrication, high reliability, low noise, low voltage and relatively high bandwidth.

2.2.3.2 Avalanche Photodiode Receivers

An avalanche photodiode (APD) is a photodiode that internally amplifies the photocurrent by an avalanche process thus making it a more sensitive receiver than a PIN photodiode. The more sensitive the receiver is, the longer the communications link can be with the given losses. The APD has a greater sensitivity by internally

amplifying the photocurrent without introducing the noise associated with external electronic circuitry [11].

A reverse bias is applied to the active region which causes the electrons generated by the incident photons to accelerate. The gain increases as the reverse bias voltage increases to approach the breakdown voltage. However in the vicinity of the breakdown voltage, a large current flows through the APD which can easily cause it permanent damage. The high bias also increases the noise levels and limits the useful gain of the APD [15].

An APD has higher gain and bandwidth than a PIN but it requires a much greater voltage to be applied across the active region. This requirement for higher power reduces the capability of miniaturization of a receiver unit and limits the possibilities of integration in communication systems [11].

2.2.4 Optical Modulation

To transmit data across an optical fiber, the information must first be encoded, or modulated, onto the laser signal. Analog techniques include amplitude modulation (AM), frequency modulation (FM), and phase modulation (PM). Digital techniques include amplitude shift keying (ASK), frequency shift keying (FSK), and phase shift keying (PSK). Of all these techniques, binary ASK currently is the preferred method of digital modulation because of its simplicity. In binary ASK, also known as on-off keying (OOK), the signal is switched between two power levels. The lower power level represents a 0 bit, while the higher power level represents a 1 bit.

In systems employing OOK, modulation of the signal can be achieved by simply turning the laser on and off (direct modulation). In general, however, this can lead to chirp, or variations in the laser's amplitude and frequency, when the laser is turned on. A preferred approach for high bit rates is to have an external modulator that modulates the light coming out of the laser. To this end, the Mach Zehnder interferometer is widely utilized [3,17].

2.2.4.1 Electro-optic Modulation System

There are two primary methods for modulating light in telecommunication systems: direct and external modulation. Direct modulation refers to the modulation of the source, i.e.: turning a laser on and off to create pulses, while external modulation uses a separate device to modulate the light. External modulation has become the dominant method for high-speed long haul telecommunication systems. External modulators can be implemented using a variety of materials and architectures [13].

2.2.4.2 Electro-Optic - Mach Zehnder Modulator (MZM)

The electro-optic MZM has become a ubiquitous device for high speed optical communication systems. It is customarily used as an intensity modulator for typical systems making use of the non return-to-zero (NRZ) or return to zero (RZ) modulation formats, and has recently demonstrated its potential for phase modulation in future systems making use of the DPSK format. Such modulators are made from an electro-optic crystal (typically lithium niobate, LiNbO₃), whose refractive index depends on the electric field, hence voltage, which is applied to it. The electrical data can thus modulate the refractive index of the crystal, hence the phase of the incoming light wave. Incorporating the crystal into an interferometric structure (Mach-Zehnder interferometer) in turn converts the phase modulation into intensity modulation [3,13].

Although the principle of such a modulator is fairly simple, its operation can present many degrees of freedom and resulting trade-offs. One particular task will be to establish relations between the extinction ratio (defined as the ratio of the power transmitted into a binary '1' and '0') of the modulated optical signal and its frequency chirping, depending on the chirp generation mechanism (optical or electrical imbalance of the MZM) [11,13].

2.2.5 Optical Amplifiers

Attenuation reduces the optical power of the signal as it travels through the fiber. Thus optical amplifiers are greatly helpful in increasing the transmission distance ability of a communication system while still enabling the signal to meet the sensitivity requirements of the optical receiver. Optical amplifiers are categorized in terms of its function as follows.

There are three basic types of amplifier with respect to its function : boosters, in-line amplifiers and preamplifiers as can be seen in Figure 2.4. Note that in the figure, the TX refer to transmitter while RX refer to the receiver. In the booster, the power amplifier is placed immediately after the transmitter. The booster raises the power of an optical signal to its maximum power, which serves to increase the transmission distance by 10-100 km depending on the amplifier gain and fiber loss. An in-line amplifier or mid-span amplifier operates with a signal in the middle of a fiber optic link and is used to compensate for power losses caused by fiber attenuation. A preamplifier magnifies a signal immediately before it reaches the receiver, thus generally operates with a weak input signal as it is located at the end of the transmission line. Good sensitivity, high gain and low noise are key requirements for a good preamplifier[11].

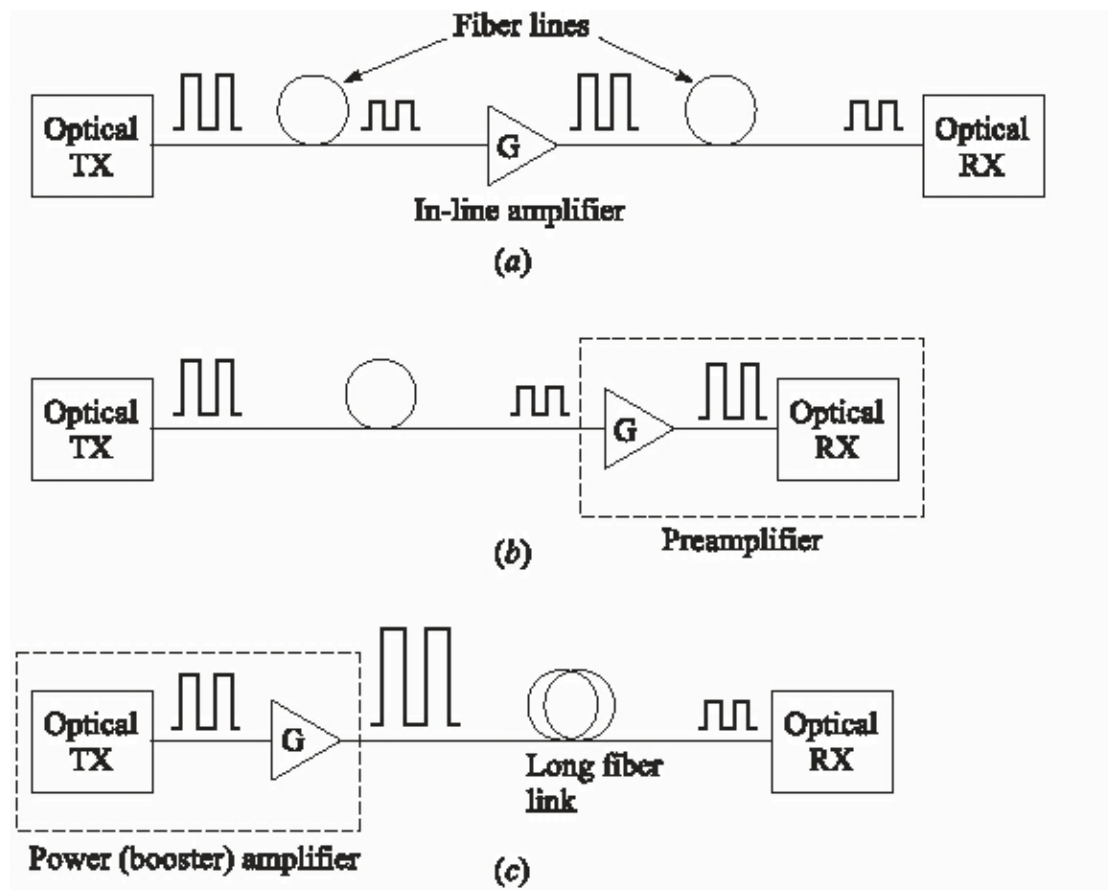

Figure 2.4: Functional types of optical amplifiers (a) in-line amplifier (b) preamplifier. (c) booster amplifier [11]

There are three main classes of optical amplifiers in use today: semiconductor optical amplifiers (SOA), fiber optical amplifiers (FOA) and fiber Raman amplifiers. This section will detail FOAs "EDFA" .

A fiber optical amplifier is a piece of specialty fiber spliced with a transmission fiber and connected to a pump laser. Both these amplifier types work on the principle of stimulated emission. Fiber amplifiers, specifically erbium-doped fiber amplifiers (EDFAs), are widely used in telecommunication networks. EDFAs operate only in the 1550nm window while SOAs can function in either 1300nm or 1550nm communications windows [11].

2.2.5.1 Erbium Doped Fiber Amplifiers (EDFA)

EDFA is one of the most widely used optical amplifiers at 1550 nm [18]. EDFAs contain a length of fiber working as an active region that is heavily doped with erbium ions and is pumped optically at 980 nm, 1480 nm or both using a semiconductor laser in the 10 to 100 milliwatt output range. The optical information and the optical pumping beams are combined onto the same fiber by a coupler; they propagate together along the doped section of the fiber where the information signal is amplified at the expense of the pumping wavelength. A second coupler removes residual pumping light from the fiber. An isolator is incorporated to prevent backwards travelling amplified spontaneous emission (ASE) from penetrating the amplifier. The gain saturation and gain recovery have a time characteristic in the millisecond range. The data which is being amplified does not have any frequency components in this range and therefore the signal is not distorted by amplification. Very high gains (54dB) with low noise figures (3.1dB) have been achieved [19]. The greatest drawback of the EDFA is its wavelength restriction. It is possible to tailor the fiber length to achieve good performance in the L-band (1565-1625nm) [20] but satisfactory performance has not been achieved in the O-band despite a great deal of research [21].

2.3 Passive Optical Networks (PON)

A PON is a network which by its nature provides a variety of broadband services to users through optical fiber access. PON allows removing all active components between the server and client introducing in place optical passive components to guide the traffic throughout the network. Its principal element is the optical splitter. Passive Optical Networking is a point-to-multipoint optical network architecture. As can be seen in Figure 2.5. Moving from the network to the user, it can say that PON architecture consists of the following equipment: an OLT at the service provider's

central office and a number of ONUs or Optical Network Terminals (ONTs) close to end users.

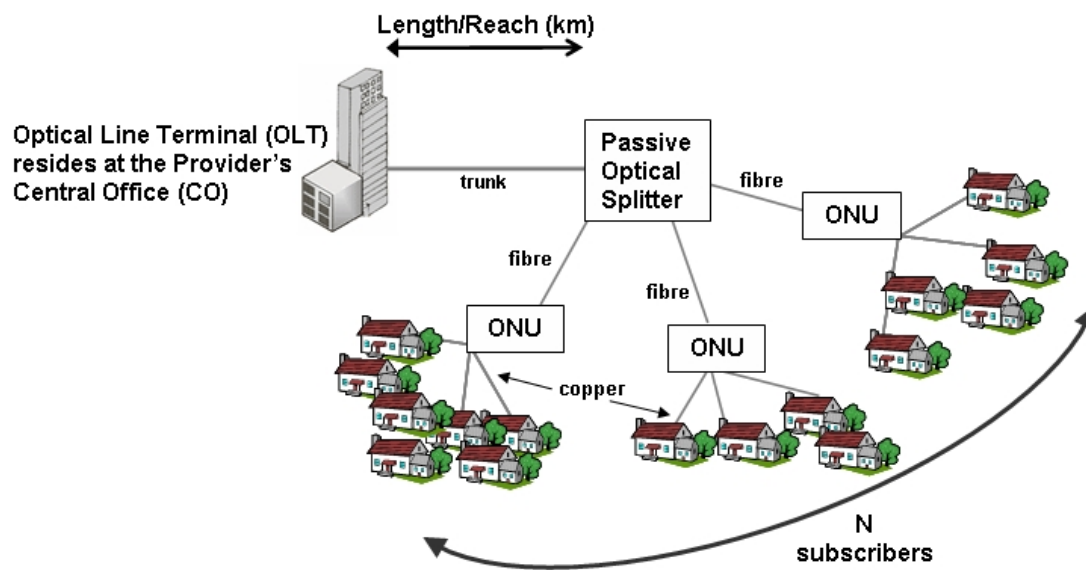

Figure 2.5: Passive Optical Networking Diagram[22].

2.3.1 Generic operation of a PON

As has been described in the previous section in general terms, a passive optical network always works under transmission between the OLT and the different ONU's through optical splitters, which multiplex or demultiplex signals based on their origin and destination. Therefore, they appear three distinct devices in the network: the OLT, the ONU and the splitter, each of which has a necessary and priority function on the passive optical network. Below are detailed the function and general characteristics each of them.

2.3.2 Optical Line Terminal (OLT)

The OLT is located in a central office and controls the bidirectional flow of information across the ODN. An OLT must be able to support transmission distances across the ODN of up to 20 km (currently could be more with EDFA). In the downstream direction the function of an OLT is to take in voice, data, and video traffic from a long-haul network and broadcast it to all the ONU modules on the ODN. In the reverse direction (upstream), OLT accepts and distributes all the traffic from the network users [23]. Simultaneous transmission of separate service types on the same fiber in the ODN is enabled by using different wavelengths for each direction. For downstream transmissions, a PON uses a 1490 nm wavelength for

combined voice and data traffic and a 1550 nm wavelength for video distribution. Upstream voice and data traffic use a 1310 nm wavelength [24]. An optical power measurement at the OLT is also required to ensure that sufficient power is delivered to the ONUs. This should be done during the initial activation because it cannot be repeated without interrupting service for the entire network once the network has been connected. Finally, note that the OLT does not emit the same light output at all ONU fairly, but depends on the distance they are from the plant. Therefore, a user close to the central need less power, while a remote user will need a higher power.

2.3.3 Optical Network Unit (ONU)

ONU is placed as the subscriber neighborhood for terminating the optical fiber transmission and converting the signals to electrical ones over metallic line to subscribers [22]. The signals will be adapted to user traffic through Network Terminal (NT). At the high performance end, an ONU can aggregate, groom, and transport various types of information traffic coming from the user site and send it upstream over a single-fiber PON infrastructure. The term grooming means that the switching equipment looks inside a time-division-multiplexed data stream, identifies the destinations of the individual multiplexed channels, and then reorganizes the channels so that they can be delivered efficiently to their destinations [23].

2.3.4 Splitter

Splitters are passive power dividers that allow communication between the OLT and their respective ONT who serve. However, not only are dedicated to multiplex or demultiplex signals, but also combine power: they are bidirectional optical distribution devices with one input and multiple outputs:

- The signal which enters from input port (downlink), it proceeds from the OLT and it is divided among multiple output ports.
- The signals which enter from the exits (uplink), they come from ONU and they are combined at the entrance.

without extern power, lowering their cost of deployment, operation and maintenance. They just introduce optical power loss on communication signals, which are inherent in nature [23].

2.3.5 Description of operation of Passive Optical Network

Once detailed all the elements that build a PON, it is necessary to know how the global system works and the behavior of the network with all the interconnected elements, from the head OLT towards ONU users, and vice versa. The most important thing to note in the generic operation of the network is the existence of two channels, one ascending and one descending. However, both generally work through the same physical cable, so different wavelengths are assigned to each transmission channel and, depending on traffic, coexisting in the same fiber at least 3 different wavelengths: one for video flow in the upstream channel, and two for data flow of uplink and downlink respectively [25]. Below is going to be analyzed in more detail both transmission channels:

2.3.5.1 Downstream channel

The downstream channel is the direction of information from the OLT operator to the ONU located on the end user. In this network, the PON behaves like a point multipoint network. The OLT includes plenty of added voice and data frames that go towards PON, through the packet optical line terminal (POLT) and the video optical line terminal (VOLT). Frames collected by these teams are transformed to signals which inject in the different branches of the users. These branches are formed by one or two fibers that carry signals bi or unidirectional, and are passively coupled by optical splitters that allow the union of all the ONT in the network, without intermediate regeneration of signals (avoiding active elements) [23].

2.3.5.2 Upstream channel

The upstream channel is the direction of information from the ONU end user to the OLT operator. In this network, the PON behaves like a point to point. Each ONU includes the added frames of voice and data (from each user) that are directed toward the OLT. At this point, the ONU performs the same operation as the OLT in the downstream channel, i.e., turn the frames into injecting signals through optical fiber that have been dedicated to the user [23].

2.3.6 GPON

The search for compatibility between equipment from different manufacturers has led to the creation of PON standards. Two standardization bodies have been active in the

access area. On the one hand, the International Telecommunication Union (ITU) with help of the Full Service Access Network (FSAN) group has created BPON (Broadband PON) and GPON (Gigabit PON) standards. On the other hand, the Institute of Electrical and Electronics Engineers (IEEE) and particularly the Ethernet in the First Mile (EFM) group is responsible for EPON (Ethernet PON) standards [21]. GPON is the more advanced standard on which is still working, it is who is born from the evolution of the BPON. All the previous standards are considered in the improvements that GPON offers. Thus, GPON works well with changes in communication technologies. In general, the improvements include increasing the bandwidth in transmission and providing security to the own network by protocol level. The Gigabit PON standard is defined in the G.984.1 recommendation (2003) [24]. The International telecommunication union's telecommunication standardization sector (ITU-T) standardized G.984 or Gigabit-capable PON (GPON) in 2003 with revisions in 2008. GPON systems are formed by an OLT and multiple ONUs or ONTs interconnecting with an ODN. Thus, there is a one-to-many relationship between the OLT and the ONU/ONTs respectively [24]. GPON supports several bit rates in both channels such as asymmetric or symmetric combinations, from 155 Mb/s to 2.5 Gb/s. Time division multiplexing (TDM) is used downstream and time division multiple access (TDMA) is implemented upstream as can be seen in figure 2.6. Its maximum physical coverage is up to 20km and its logical reach can be up to 60km. There is a trade off between the PON length and its splitting capability, with a maximum of 128 ONUs per OLT, however a split ratio of 32 is common today [23].

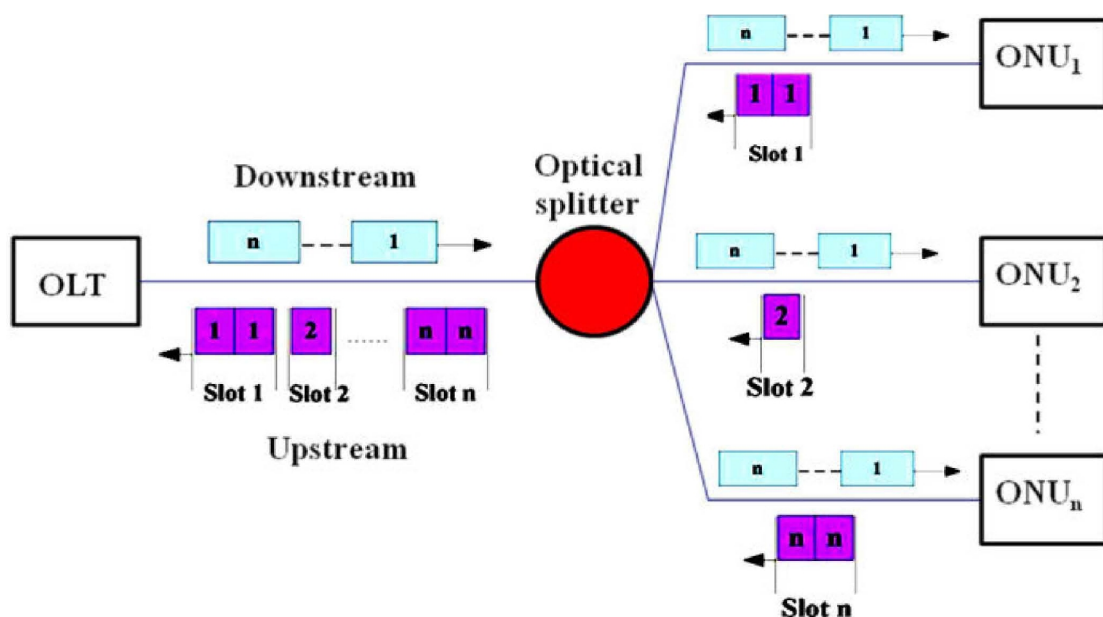

Figure 2.5: GPON Architecture [1]

2.3.8 Why GPON

GPON is the fastest commercially available member of the PON family of technologies, which also includes Broadband PON (BPON) and Ethernet PON (EPON). GPON and EPON were the two competing systems in the beginning of 2009 due to the fact that GPON and EPON offered more bandwidth per subscriber than BPON. EPON has mostly thrived in Eastern Asia countries such as China, Korea and Japan, whereas GPON has succeeded very well in the North America. GPON is a more advanced system than EPON from the technological parameters point of view. It provides higher bandwidth efficiency and higher splitting ratio but generally costs more than EPON. The cost per EPON ONU link was about 78 % compared to that of GPON [24].

GPON had a technical market advantage in that its transmission convergence layer natively accommodated not only encapsulation of native Ethernet frames, but also of Asynchronous Transfer Mode (ATM) cells and TDM services. This capability made it an ideal choice for carriers wishing to deliver simultaneous voice and data services to their customers.

3.1 Introduction

The proposed promising cost effective solution to meet ever increasing user bandwidth and wireless demand is the Wireless networks based on RoF technologies. Since it was first demonstrated for cordless or mobile telephone service in 1990, many research has been carried out to consider its limitation and develop new and high performance RoF technologies [26]. In this network a CS is connected to numerous functionally simple BS via an optic fiber. The main function of BS is to convert optical signal to wireless one and vice versa. Almost all processing including modulation, demodulation, coding, routing is performed at the CS. This means that, RoF networks use highly linear optic fiber links to distribute RF signals between CS and BS

At minimum, RoF architecture link consists of all the hardware required to impose an RF signal on an optical carrier, the fiber-optic link, and the hardware required to recover the RF signal from the carrier. The general RoF architecture is shown in figure 3.1. Note that the optical carrier's wavelength is usually selected to coincide with either the 1.3 nm window, at which standard single-mode fiber has minimum dispersion, or the 1.55 nm window, at which its attenuation is minimum [13].

As the requirement of high data rate can not be satisfied by decreasing cell size or by allocating more bandwidth because both these methods lead to increased complexity of base station, RoF networks come into picture. RoF technology has emerged as a cost effective technique for decreasing radio system costs because it simplifies the remote antenna sites and enhances the sharing of expensive radio equipment located at appropriately sited Switching Centers (SC) or otherwise known as Central Sites/Stations (CS) [13].

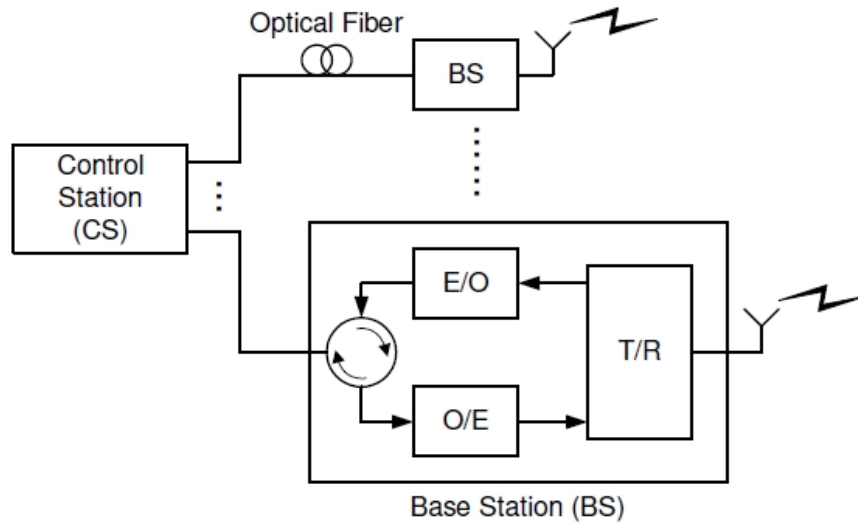

Figure 3.1: General RoF Architecture [13]

3.2 RoF link configurations

There are several approaches for transporting radio signals over optical fiber in RoF systems, which is classified based on the kinds of frequency bands (RF bands, Intermediate Frequency IF, baseband (BB)) transmitted over an optical fiber link. The three fundamental techniques as shown in Figure 3.2 [13].

- a) In baseband-RoF, a message data signal is used to modulate the light wave to transfer through the optical link. In other word, the message signal is the modulating signal and the light wave is the carrier signal [13].
- b) In RF-RoF, a Radio Frequency signal with a high frequency is modulated with an optical light wave signal before being transported over the optical link. Therefore, wireless signals (RF signal) are optically distributed to base stations directly at high frequencies and there is no need to any up/ down conversions, thereby a less cost system is obtained [27].
- c) In IF-RoF, an Intermediate Frequency radio signal with a lower frequency is used for modulating light before being transported over the optical link. Therefore, wireless signals are transported at intermediate frequency over the optical [27].

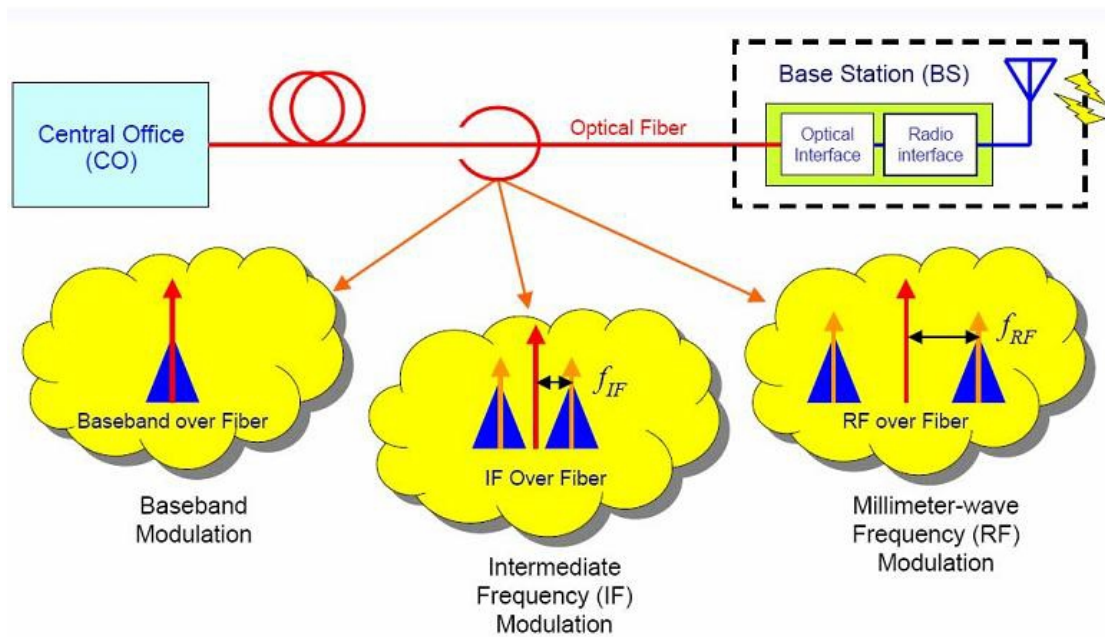

Figure 3.2: Radio signal transport schemes for RoF systems [13]

3.3 Benefits of RoF Technology

Some of the advantages and benefits of the RoF technology compared with electronic signal distribution are given below.

3.3.1 Low attenuation loss

When transmitting signals in free space or through transmission lines, the electrical distribution of high-frequency microwave signals is difficult and costly. Absorption and reflection increase as the frequency increase in free space, thus, all of that increase losses [28]. Also, As the frequency rises the impedance increase in transmission lines, and leading to very high losses [29]. Therefore, distributing high frequency radio signals electrically over long distances requires expensive regenerating equipment.

The attenuation losses in standard Single Mode Fibers (SMFs) made from glass in the 1550 windows are below 0.2 dB/km and 0.5 dB/km in the 1300 nm windows. The most recent kind of optical fiber is polymer optical fibers (POFs), exhibits higher attenuation ranging from 10–40 dB/km in the 500–1300 nm regions [30,31]. Any other transmission mediums such as coaxial cable have losses much greater than those encountered in any optical fiber type such as POF. Note that the losses increase as frequency increase, nearly the losses in coaxial are higher by three orders of

magnitude at higher frequencies. For instance, the attenuation of a half inch diameter coaxial cable (RG-214) is >500 dB/km for frequencies above 5 GHz [32]. Therefore, by transmitting microwaves in the optical form, transmission distances are increased several folds and the required transmission powers reduced greatly.

3.3.2 Large Bandwidth

One of the most important Benefit of Optical fibers is the huge bandwidth. In SMF, the total BW of the three transmission windows proposed low attenuation (850 nm, 1310 nm, and 1550 nm) is nearly 50 THz [33]. Just only a fraction of this capacity (1.6 THz) the today's commercial systems can utilized. The developments to exploit more optical capacity per single fiber are still continuing. The main driving factors towards the ability of utilize more bandwidth out of the optical fiber including the availability of low dispersion (or dispersion shifted) fiber, the Erbium Doped Fiber Amplifier (EDFA) for the 1550 nm window, and the use of advanced multiplex techniques namely Optical Time Division Multiplexing (OTDM) in combination with Dense Wavelength Division Multiplex (DWDM) techniques [34].

3.3.3 Immunity to Radio Frequency Interference

Immunity to electromagnetic Interference (EMI) is a very attractive property of optical fiber communications Especially for microwave transmission. This is so because signals are transmitted in the form of light through the fiber. Even for short connections, fiber cables are preferred at high frequencies because of this immunity [34].

3.3.4 Dynamic Resource Allocation

In RoF, The switching, modulation, and other RF functions are performed at a centralized headend, so it is possible to allocate capacity dynamically. For instance in a RoF distribution system for Global system mobile (GSM) traffic [34].

Some area such as shopping mall can allocate more capacity during peak times and then re-allocated to other areas such as populated residential areas in the evenings. when offpeak. This can be achieved by allocating optical wavelengths through wavelength division multiplexing (WDM) as need arises [3] .

3.3.5 Lower Cost

Most RoF techniques eliminate the need for a local oscillator and related equipment at the remote station (RS). Simpler structure of remote base station means lower cost of infrastructure, lower power consumption by devices and simpler maintenance, all of these contribute to lower the overall installation and maintenance cost [34] .

3.4 Applications of RoF Technology

Since RoF technology was first demonstrated for cordless or mobile telephone service in 1990, a lot of research efforts have been made to investigate its limitation and develop new, high performance RoF technologies [26]. Some of the applications of RoF technology include satellite communications, Cellular Networks, vehicle communications and control, and wireless LANs over optical networks. The main application areas are briefly discussed below.

3.4.1 Cellular Networks

One of the most important application area of RoF is the Mobile networks. The increasing demand for broadband services coupled with the continuous increasing in the number of mobile subscribers have made continuous pressure on mobile networks to offer increased capacity. Therefore, mobile traffic can be relayed cost effectively between the SCs and the BSs by exploiting the benefits of SMF technology. Other RoF functionalities such as dynamic capacity allocation offer significant operational benefits to cellular networks [34].

3.4.2 Satellite Communications

One of the first practical uses of RoF technology was the Satellite communications. One of the applications involves the remoting of antennas to suitable locations at satellite earth stations. At this, small optical fiber links of less than 1km and operating at frequencies between 1GHz and 15GHz are used. The second application involves the remoting of earth stations themselves. With the use of RoF technology the antennae need not be within the control area (e.g. Switching Center). They can be sited many kilometers away for the purpose of, for instance improved satellite visibility or reduction in interference from other terrestrial systems. Switching equipment may also be appropriately sited, for say environmental or accessibility reasons or reasons [34].

3.4.3 Wireless LANs

Portable devices and computers become more and more powerful as well as widespread. Thus, the demand for mobile broadband access to LANs will be on the increase. This will lead to higher carrier frequencies in the bid to meet the demand for capacity. For instance current wireless LANs operate at the 2.4 GHz ISM bands and offer the maximum capacity of 11 Mbps per carrier (IEEE 802.11b). The broadband wireless LANs are offered up to 54 Mbps per carrier, and will require higher carrier frequencies in the 5 GHz band (IEEE802.11a/D7.0) [35]. Higher carrier frequencies in turn lead to micro- and Pico-cells, and all the difficulties associated with coverage arise. A cost effective way around this problem is to deploy RoF technology.

3.4.4 Vehicle Communication and Control

The vehicle control is considered as potential application area of RoF technology. Frequencies between 63-64 GHz and 76-77 GHz have already been allocated for this service within Europe. The objective is to provide continuous mobile communication coverage on major roads for the purpose of intelligent transport systems (ITS) such as road-to-vehicle communication (RVC) and inter-vehicle communication (IVC). ITS systems aim to provide traffic information, improve transportation efficiency, reduce burden on drivers, and contribute to the improvement of the environment [13]. In order to achieve the required (extended) coverage of the road network, numerous base stations are required. These can be made simple and of low cost by feeding them through RoF systems, thereby making the complete system cost effective and manageable [34].

3.5 Digital Modulation

Modulation refers to the representation of digital information in terms of analog waveforms that can be transmitted over physical channels. Typically the objective of a digital communication system is to transport digital data between two or more nodes. In radio communications this is usually achieved by adjusting a physical characteristic of a sinusoidal carrier, either the frequency, phase, amplitude or a combination thereof. This is performed in real systems with a modulator at the transmitting end to impose the physical change to the carrier and a demodulator at the receiving end to detect the resultant modulation on reception [36].

3.5.1 Phase Shift Keying (PSK)

PSK is a large class of digital modulation schemes. Thus, PSK is widely used in the communication industry. One of the simplest forms of PSK is the binary phase shift keying BPSK. It uses two phases which are separated by 180° and so it is termed 2-PSK. It does not particularly matter exactly where the constellation points are positioned, they are shown on the real axis at 0° and 180° in Figure 3.3. The distance of the two symbols is a maximum distance and it takes the highest level of noise or distortion to make the demodulator reach an incorrect decision. In the case of a limited bandwidth; it is, however, unsuitable for high data-rate applications since it is only able to modulate at 1 bit/symbol. In the presence of an arbitrary phase-shift introduced by the communications channel, the demodulator is unable to tell which constellation point is which. As a result, the data is often differentially encoded prior to modulation [37].

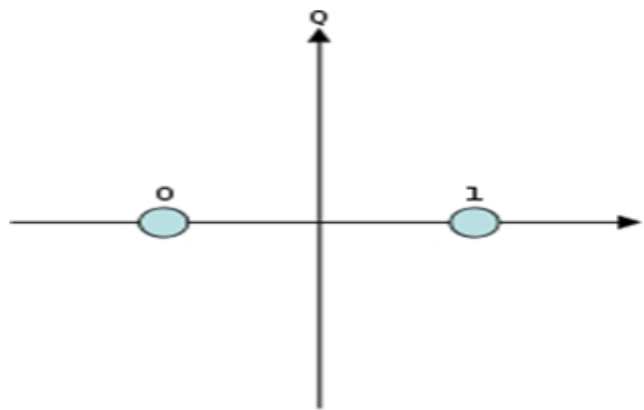

Figure 3.3: Constellation diagram for BPSK [37].

3.5.2 Quadrature phase-shift keying (QPSK)

It is known as quaternary PSK. It uses four points on the constellation diagram, equispaced around a circle. With four phases, QPSK can encode two bits per symbol. QPSK can be used either to double the data rate compared with a BPSK system while maintaining the same bandwidth of the signal, or to maintain the data rate of BPSK but halving the bandwidth needed. In the second case, the BER of QPSK is exactly the same as the BER of BPSK, so the advantage of QPSK over BPSK becomes evident [37]. The constellation diagram for QPSK is shown in figure 3.4.

Phase modulation with phase offset is usually abbreviated as O-PSK, where the O indicates the offset. For example, QPSK modulation with quadrature offset is referred

to as OQPSK. OQPSK has the same spectral properties as QPSK for linear amplification, but has higher spectral efficiency under nonlinear amplification, since the maximum phase transition of the signal is 90 degrees, corresponding to the maximum phase transition in either the in-phase or quadrature branch, but not both simultaneously [38].

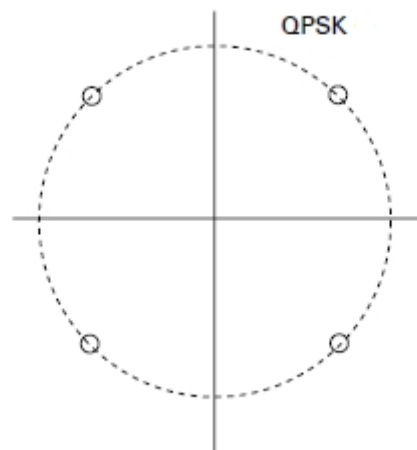

Figure 3.4: Constellation diagram for QPSK [38]

3.5.3 Differential Phase shift keying (DPSK)

DPSK modulation uses standard PSK constellations, but encodes the information in the phase transitions between successive symbols rather than in the absolute phase of one symbol. This allows recovery of the information even when there is no absolute phase reference. In non differential or coherent modulation, an estimate of the channel phase and attenuation is recovered. It is then possible to reproduce the transmitted signal, and demodulate. It is necessary to have an accurate version of the carrier, otherwise errors are introduced. The transmitter in differential modulate each symbol in relative to the previous symbol, for DPSK: 0 = no change and 1 = +180°. In the receiver, the current symbol is demodulated using the previous symbol as a reference. The previous symbol acts as an estimate of the channel [37].

Differential reception is theoretical 3dB poorer than coherent. This is because the differential system has two sources of error: a corrupted symbol, and a corrupted reference (the previous symbol). Non-coherent reception is often easier to implement [36].

4. Design of the RoF Employed GPON Architecture

4.1 Introduction

This section will describe the design of RoF employed GPON Architecture. The methods of simulation and its parameter will be shown and described. The purpose is to show the behavior of links of optical fiber when the signal goes through all the elements such as optical fiber, splitters, and the goal is to find a good quality of signal in all receivers. The final goal pursued with this thesis is to evaluate the performance of the whole system.

The parameters used to evaluate this behavior will be the BER, Q factor and eye diagram. The first condition used to assess the performance of the link is generally BER at the receiver. Simulations are done trying to approach at the receiver a minimum BER. The minimum BER accepted to the GPON is 10^{-10} [39]. The second condition corresponds to the Q factor which may be necessary in the case of difficult measurements of BER in high performance transmission link. System Q factor adopts the concept of S/N ratio in a digital signal. The minimum value of Q that will enable an error-free system is 6. Usually much higher values of Q would be expected of a practical system [40]. The third condition corresponds to the eye diagram. Viewing this diagram it can describe the quality of the received signal. In the presence of ISI, when the pulse does not satisfy the Nyquist criterion, the diagram will tend to close vertically. For error-free transmission in the absence of noise, the eye must be kept some vertical opening, or otherwise it will exist interference between symbols that will cause errors. When the eye is not fully closed, the interference between symbols reduces the value of allowable additive noise. Therefore, the higher vertical opening the greater immunity to noise.

The following sections will describe the design, of RoF Employed GPN Architecture.

Firstly, the system of RoF employed GPON architecture will be modeled including the behavior of the system blocks such as transmitter and receiver in downstream and

upstream channel. Secondly, the system will be tested for PSK, DPSK and OQPSK modulation respectively with fiber length of 20km. Finally the performance of the system for different modulation schemes and fiber lengths will be evaluated, then a comparison will be introduced.

4.2 System Model of Bidirectional Transmission for RoF employed GPON Architecture

This section briefly describes the simulation setup in OptiSystem where all necessary parameters are based on the GPON standardized properties. The proposed RoF employed GPON system model is shown in figure 4.1 while figure 4.2 show the optisystem implementation of the system.

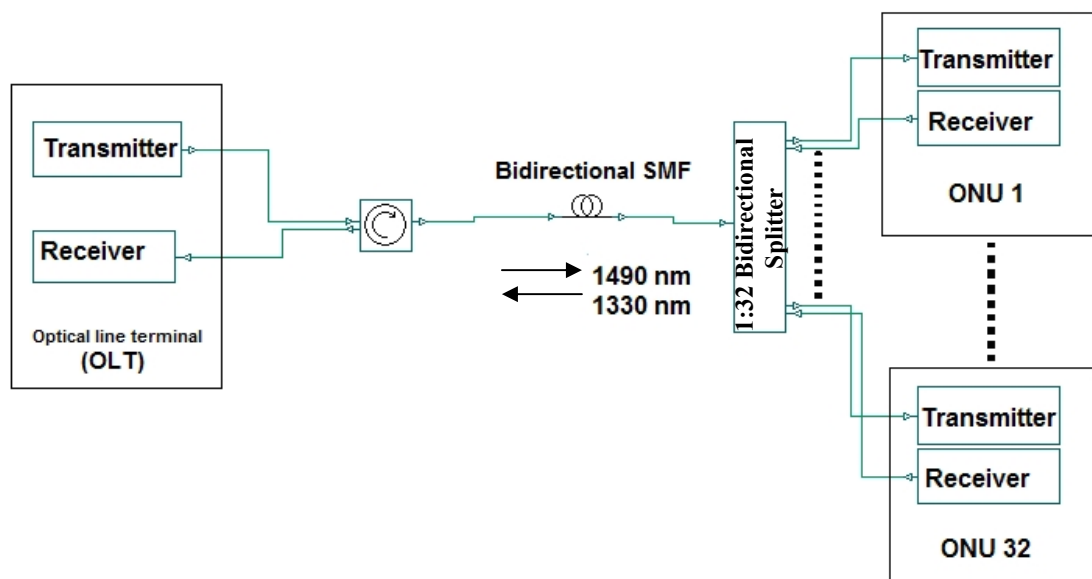

Figure 4.1: Schematic of a bidirectional RoF system

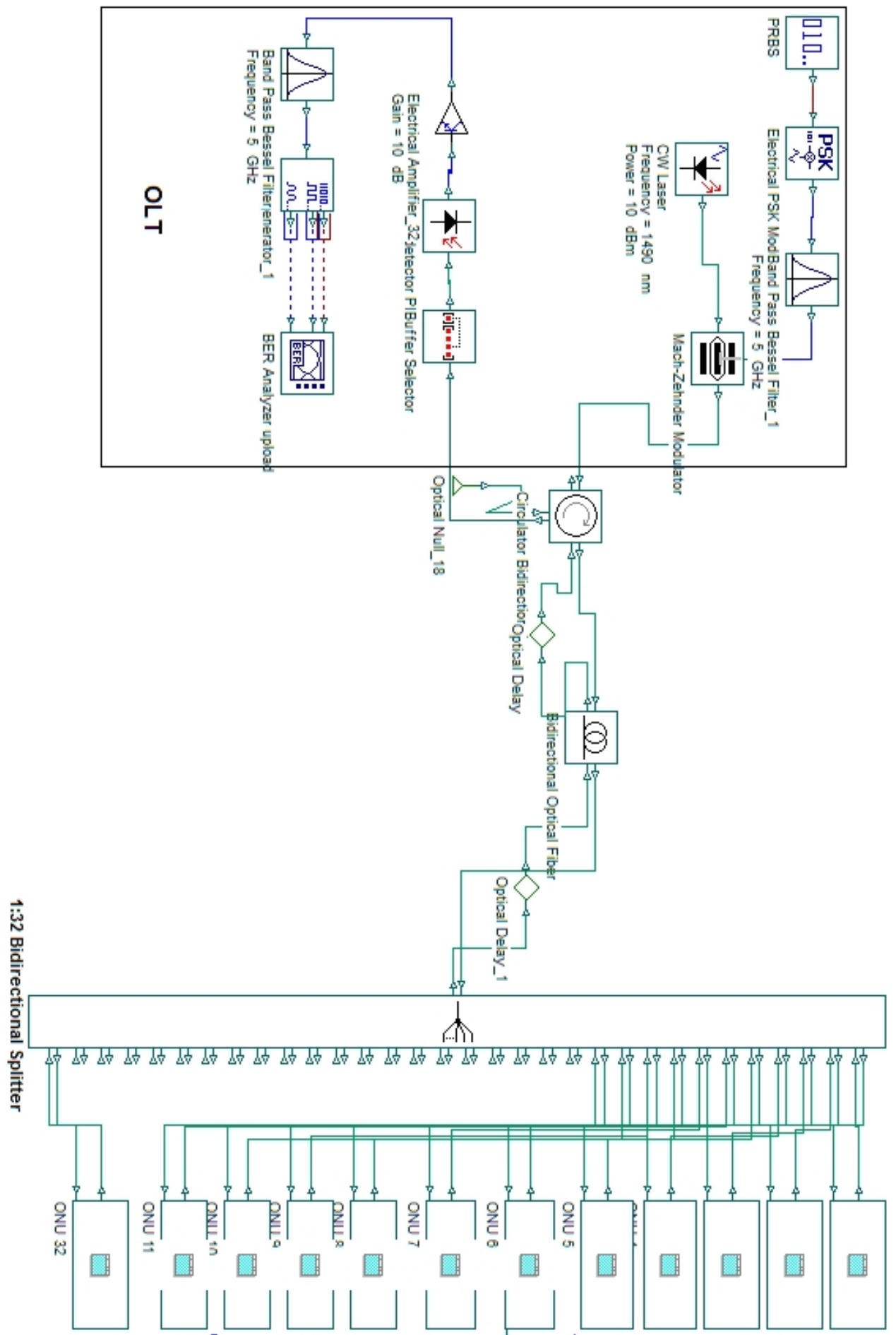

Figure 4.2: System model in optisystem

The design in figure 4.1 shows the development of the bidirectional transmission for RoF employed GPON architecture. One transmitter and one receiver are used at OLT and distributed to the 32 ONUs. Bidirectional fiber is used with length up to 60 km. A bidirectional 1:32 passive optical splitter is used to connect the ONU's to the backbone fiber. Finally, the upstream and downstream signal separated by the optical circulator and optical delay introduced at the fiber to ensure the correct timing of circulation. Figure 4.3 shows the schematic design of transmitter and figure 4.4 shows the receiver module that is identical for both OLT and ONU.

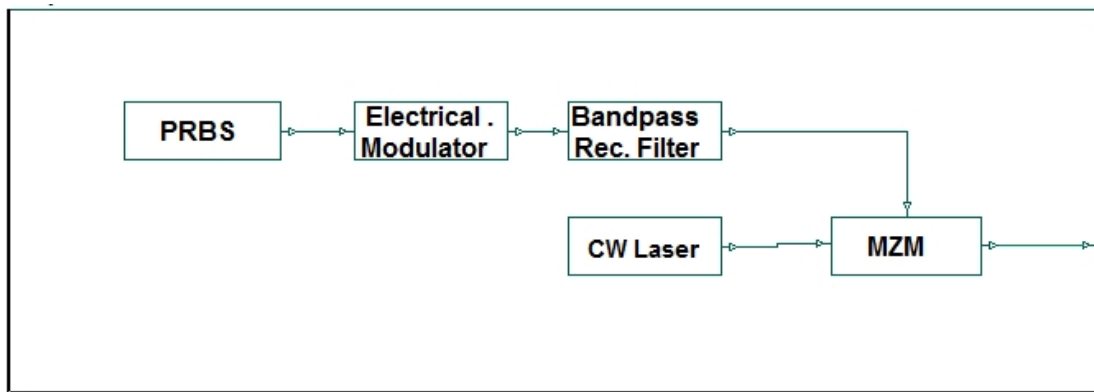

Figure 4.3: Transmitter in the bidirectional RoF system

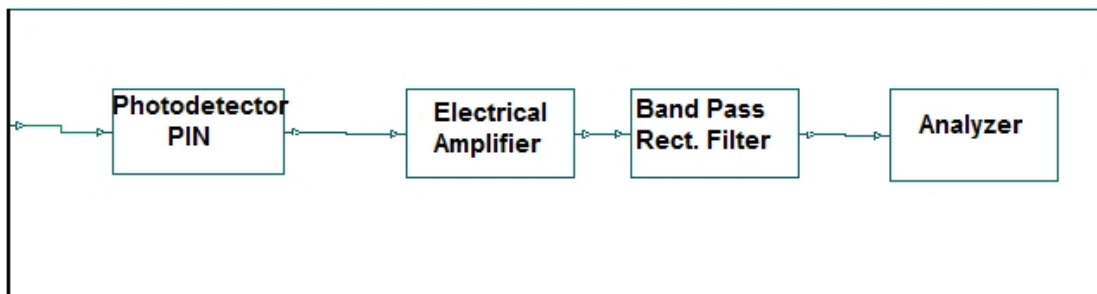

Figure 4.4: Receiver in the bidirectional RoF system

At the transmitter, the data signal is generated by the Pseudo-Random Bit Sequence Generator (PRBS) where the bit rate is set at 2.5 Gbps and the chosen working frequency is 5 GHz which operated as IEEE 802.11a signal. The data is then modulated by a PSK modulator. Band-pass filter (BPF) used at both transmitter and Receiver to obtain only the required spectrum. The optical modulation that consists of CW laser diode (LD) and MZM which works at 1490 nm prepared the electrical signal to be transported through the bidirectional fiber. At the receiver, after photodetection by PIN, the signal is amplified and filtered to regenerate the desired

signal. The signal then fed into the spectrum and BER analyzers for data analysis. The main components used in the system are as follows:

Pseudo Random Binary Sequence (PRBS): Generates bits stream a according to different operation modes. The bit sequence is designed to approximate the characteristics of random data.

Mach-Zehnder Modulator (MZM): Modulators are the devices used to modulate the beam of light according to the modulating signal which is the electrical signal that will be carried over the light.

Positive-Intrinsic-Negative photodetector (PIN-PD): It is used to convert the optical signal to electrical signal.

Bidirectional single mode fiber (SMF): The cable simulates the bidirectional propagation of arbitrary configuration of optical signals in a single-mode fiber.

bidirectional Splitter 1x32 : This device splits evenly the signal input power to 32 output ports in the downstream and act as a combiner in the upstream to combine 32 input to one output.

Continuous Wave Laser (CW laser): it is used to convert electrical signal to optical signal and it generates CW optical signal.

Phase Shift Keying (PSK): Encodes and modulates a binary signal to an electrical signal using phase shift keying modulation (PSK).

Differential Phase Shift Keying (DPSK): Encodes and modulates a binary signal to an electrical signal using differential phase shift keying modulation (DPSK).

Offset Quadrature Phase Shift Keying (OQPSK): Encodes and modulates a binary signal to an electrical signal using offset quadrature phase shift keying modulation (OQPSK).

4.2.1 Downstream link

In downstream, the optical signal will direct from the OLT to the end users at ONU's. The signal will travel from the transmitter at the OLT to the receiver in the ONU at 1490 nm pass through bidirectional SMF and a splitter. The system composed of a transmitter in OLT, Bidirectional SMF, splitter and 32 receivers at the ONU's, one receiver for each ONU.

4.2.1.1 Transmitter

The transmitter in the downlink is shown in figure 4.3. The data signal is generated by the PRBS where the bit rate is set at 2.5 Gbps and the chosen working frequency is 5 GHz which operated as IEEE 802.11a signal. The data is then modulated by a PSK modulator. BPF used to obtain only the required spectrum. The PSK modulated signal is illustrated in Figure 4.5 the central frequency of the signal is 5 GHz with 3.75 GHz major bandwidth from 3.125 GHz to 6.875 GHz in two sidebands. The optical modulation that consists of LD and MZM which works at 1490 nm prepared the electrical signal to be transported through the bidirectional fiber. The MZM has three ports: the first port is for electrical modulation type, the second is the CW laser input and the third port is the outlet of output optical signal. The extinction ratio is set to 30 dB to characterize the division power ratio of the upper path to lower path. The modulation at the MZM can be seen in Figure 4.6. It is clear that the output optical signal is symmetry about 1490 nm The hardware configurations of the transmitter side are summarized in Table 4.1. The output power is measured by using the optical power meter after MZM $P = 6.9$ dBm.

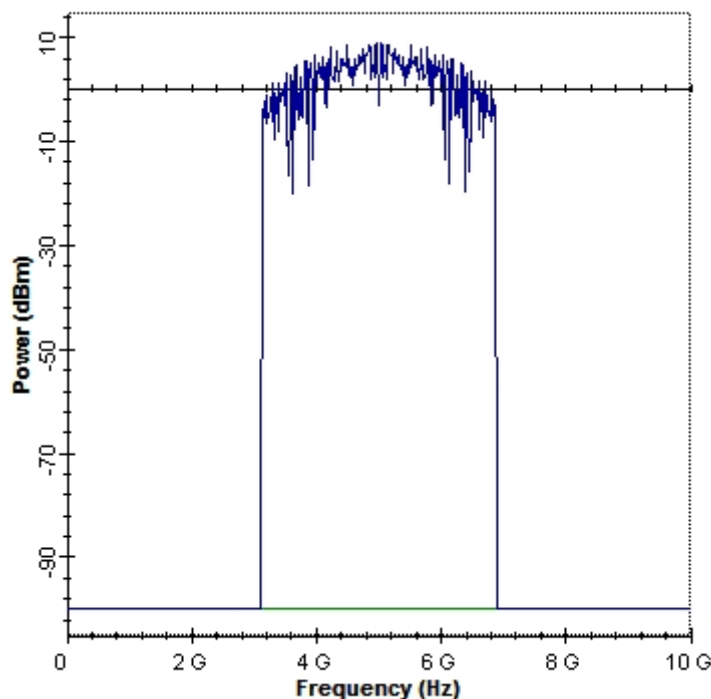

Figure 4.5: PSK Modulated signal

Table 4.1 Hardware configurations of the transmitter in Downstream

Quantity	Value
Pseudo Random Bit Sequence (PRBS) Generator	2.5 Gbps
Laser Diode	Frequency = 1490 nm Power = 10 dBm Line width = 10 MHz Initial phase = 0 deg
Phase Shift Keying (PSK) Modulator	Frequency = 5 GHz Amplitude = 1 a.u. Phase offset = 45 deg Bias = 0 a.u.
Mach-Zehnder Modulator	Extinction ratio = 30 dB
Rectangle band-pass filter	Frequency = 5 GHz Band width = 3.75 GHz

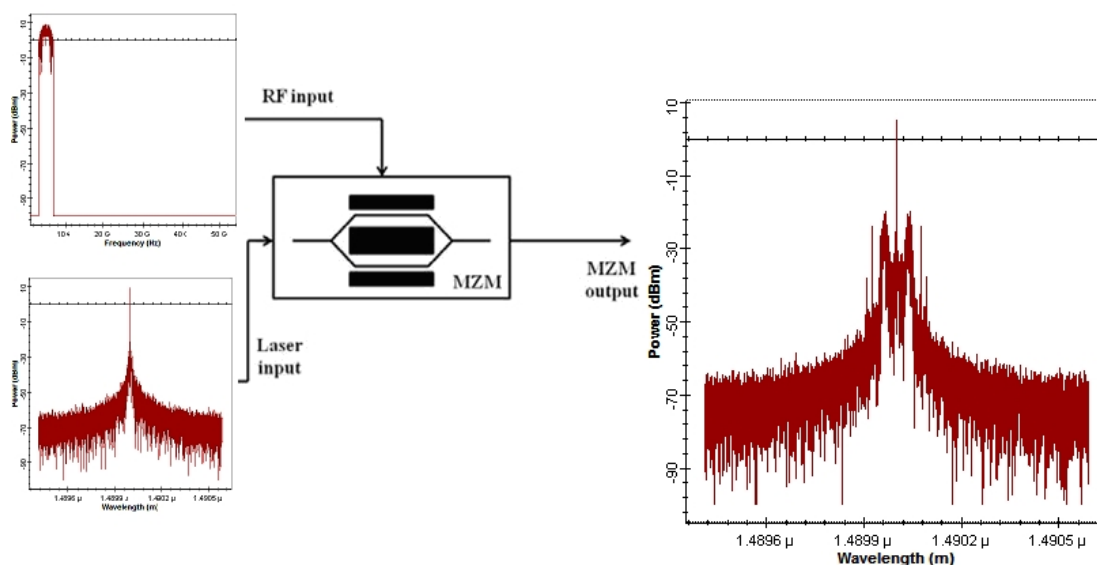

Figure 4.6: modulation at the MZM

4.2.1.2 Circulator

the upstream and downstream signal separated by the optical circulator and optical delay introduced at the fiber to ensure the correct timing of circulation. Optical

circulator has insertion losses of 0 dB and return losses of 65 dB. So the power after the circulator has no change $P=6.9$ dBm .

4.2.1.3 Fiber

A bidirectional SMF is used to forward the signal and to backward it with an optical delay of 1 unit in order to separate the upstream and downstream. Table 4.2 shows the main parameters of a bidirectional optical fiber. The fiber cable has an attenuation loss of 0.2 dB/km and varied length from 10 km to 60 km, this means there is a 0.2 dB/km*10 km "suppose fiber length = 10 km" which equal to 2 dBm power loss, so that the resultant signal power is equal to 6.9 dBm -2 dBm = 4.9 dBm (Theoretical Analysis). On other hand, the measured signal power after travelling through the optical fiber cable is equal to 4.9 dBm, so that there is a matching between theoretical analysis and simulated measurements.

Table 4.2 Hardware configurations of the fiber

Quantity	Value
Reference wavelength	1490 nm
Attenuation	0.2 dB /km
Dispersion	16.75 ps nm ⁻¹ km ⁻¹
Length	10, 20 , 40 ,60 Km
Dispersion slope	0.075 ps/nm ² /km

4.2.1.4 Splitter

Passive splitters are used that enables single feeding fiber from the provider's central office to serve multiple homes and small business. the optical signals are transmitted to the optical splitter. The optical splitter splits the signal into required number of signal streams to transmit it to customer premises. Theoretically, the splits can be up to 64 but due to the current hardware limitations, the development so far can only reach 32. Thus, a bidirectional 1:32 passive optical splitter is used to connect the ONUs to the backbone fiber. The splitter has the following properties listed in table 4.3. The measured and calculated value of signal power enter the splitter equal to 4.9 dBm = 3.091×10^{-3} Watt. The splitter will split the incoming power to 32 equal signal. Thus, the theoretical output power will be $3.091 \times 10^{-3} / 32 = 96.59 \times 10^{-6}$ Watt. The signal

power after the splitter is $P = -10.15 \text{ dBm} = 96.59 \times 10^{-6} \text{ Watt}$. So that there is a matching between theoretical analysis and simulated measurements.

Table 4.3 Hardware configurations of the Splitter

Quantity	Value
Splitter bidirectional	1x32
Insertion loss	0 dB
Return loss	65 dB

4.2.1.5 Receiver

The Receiver in the downstream is shown in figure 4.3. The optical signal is received by photodetector PD operating at 1490 nm frequency to convert it back to electrical form, the received signal after photo detection is illustrated in Figure 4.7. It is clear that the central frequency of the signal is about 5 GHz; also it is clear that there is a power loss and signal distortion due to conversion process in spite of using sampling rate in PD five times of the main sampling rate, the signal power decreases to -39.29 dBm. To recover the message signal; a BPF is used with central frequency of 5 GHz and 3.75 GHz bandwidth. These hardware configurations are summarized in Table 4.4.

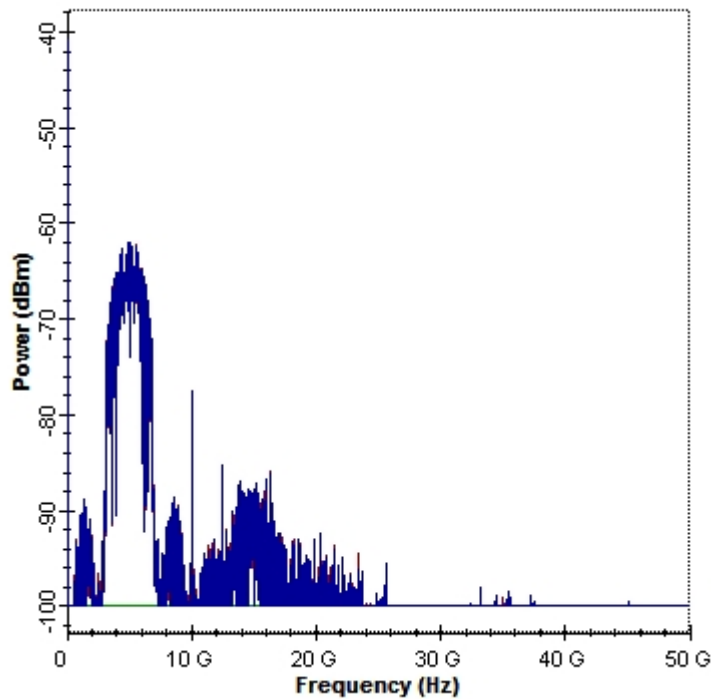

Figure 4.7: The electrical signal after PIN.

The resultant signal power after the BPF and electrical amplification is about -34.76 dBm, the power losses in BPF is due to the signal cutting. After receiving and filtering the signal, 3R regenerator is used and connected directly to the BER Analyzer. 3R regenerator has three outputs; the first output port is the bit sequence, the second one is a reference signal and the last one is the output signal. These three signals can be connected directly to the BER Analyzer, avoiding additional connections between transmitter and the receiver stage.

Table 4.4 Hardware configurations of the Receiver

Quantity	Value
Photodetector	type PIN responsivity = 3 AW Dark current = 10 nA
Filter	type : Band pass rectangle filter frequency = 5 GHz insertion loss = 0 dB Depth = 100 dB
Electrical amplifier	gain = 10 dB

4.2.2 Upstream

In upstream, the optical signal will direct from the end users "ONU's" to the OLT. The signal will travel from the transmitter at the ONU to the receiver in the OLT at 1330 nm pass through a splitter and bidirectional fiber. As in the down stream the system composed of 32 transmitter "one transmitter for each ONU " , splitter , Bidirectional Fiber and a receiver at the OLT.

4.2.2.1 Transmitter

The transmitter in the uplink shown in figure 4.2 . As in the downstream, the data signal is generated by the PRBS where the bit rate is set at 2.5 Gbps and the chosen working frequency is 5 GHz. The data is then modulated by a PSK modulator. BPF used to obtain only the required spectrum. The PSK modulated signal is illustrated in figure 4.5 the central frequency of the signal is 5 GHz with 3.75 GHz major bandwidth from 3.125 GHz to 6.875 GHz in two sidebands. The optical modulation that consists of LD and MZM which work at 1330 nm prepared the electrical signal to

be transported through the bidirectional SMF. The extinction ratio is set to 30 dB to characterize the division power ratio of the upper path to lower path. The modulation at the MZM can be seen in Figure 4.8. It is clear that the output optical signal is symmetry about 1330 nm. The hardware configurations of the transmitter side are summarized in Table 4.5.

Table 4.5 Hardware configurations of the transmitter in Upstream

Quantity	Value
Pseudo Random Bit Sequence (PRBS) Generator	2.5 Gbps
Laser Diode	Frequency = 1330 nm Power = 10 dBm Line width = 10 MHz
Phase Shift Keying (PSK) Modulator	Frequency = 5 GHz Amplitude = 1 a.u. Phase offset = 45 deg Bias = 0 a.u.
Mach-Zehnder Modulator	Extinction ratio = 30 dB
Rectangle band-pass filter	Frequency = 5 GHz Band width = 3.75 GHz

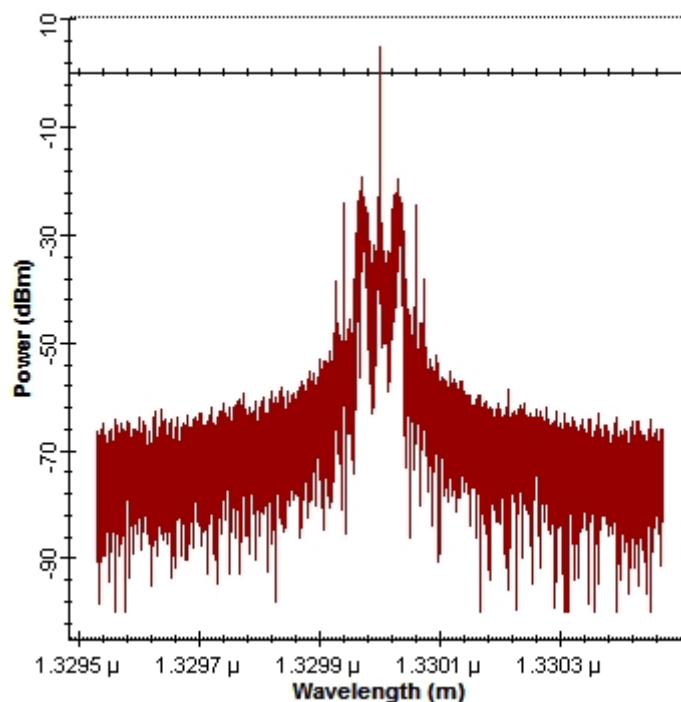

Figure 4.8: The MZM transmitted signal at 1330 nm.

In the case of upstream, it has more than one transmitter operating on the same wavelength, it must take into account the TDMA. Therefore it will use two cascaded Dynamic Select Y as shown in figure 4.9 which they will allow to pass the signal only at a determined time instant and the rest will be zero. In the beginning, the parameter TimeSlot for every ONU has been defined and assign value of 0 to the first ONU, 1 for the second ONU and so on until reach TimeSlot=31 for ONU number 32. later for each one Dynamic Y select, the time interval or switching time will be defined to has the following value. For component A:

$$\text{switching time} = \text{TimeSlot} * (1/\text{Bit rate}) * \text{Sequence length} / 32$$

The number 32 refer to 32 ONU. For component B, switching time will be defined to:

$$\text{Switching time} = \text{Timeslot} * (1/\text{Bit rate}) * \text{Sequence length} / 32 + \text{Time window} / 32$$

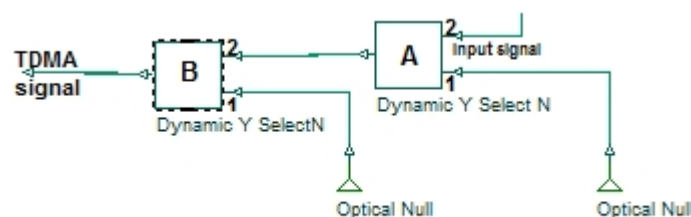

Figure 4.9: implementation of TDMA using two cascaded dynamic Y selector

In component A properties, port before switching is port1 and after switching is port 2, while in component B the port before switching is port2 and after switching is port1 [40]. Now lets explain the idea on ONU1, ONU16 and ONU32. Time window = 51.2 nano second (ns), Bit rate = 2.5 Gbps and Sequence length=128 Bit. Firstly, for ONU1, TimeSlot =0, Switching time for component A = 0 ns and switching time for component B = 1.6 ns. Component A will pass the input signal (port 1) to the output from 0 ns to the end of time window, while component B will allow to pass the signal from switching time of component A to the switching time of component B. This means that the signal will pass to the output from 0 ns to 1.6 ns second and the rest will be zero. Figure 4.10 shows the signal transmitted by ONU1. Secondly, for ONU16, TimeSlot =15, Switching time for component A = 24 ns and switching time for component B = 2.56 ns. Component A will pass the input signal to the output from

24 ns to the end of time window, while component B will allow to pass the signal from switching time of component A to the switching time of component B. mean the signal will pass to the output from 24 ns to 2.56 ns and the rest will be zero. Figure 4.11 shows the signal transmitted by ONU16. Thirdly, for ONU32, TimeSlot=31, Switching time for component A=49.6 ns and switching time for component B = 51.2 ns. Component A will pass the input signal to the output from 49.6 ns to the end of time window, while component B will allow to pass the signal from switching time of component A to the switching time of component B. mean the signal will pass to the output from 49.6 ns to 51.2 ns and the rest will be zero. Figure 4.12 shows the signal transmitted by ONU32. This proves that the signals transmitted by the various ONU's do not overlap in time:

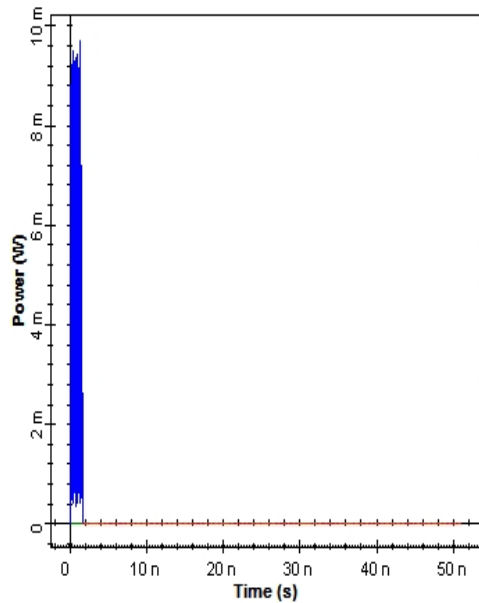

Figure 4.10: Signal transmitted by ONU1 in time domain

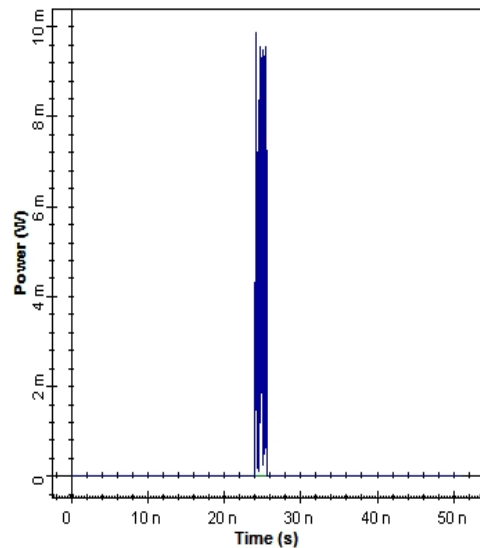

Figure 4.11: Signal transmitted by ONU 16 in time domain

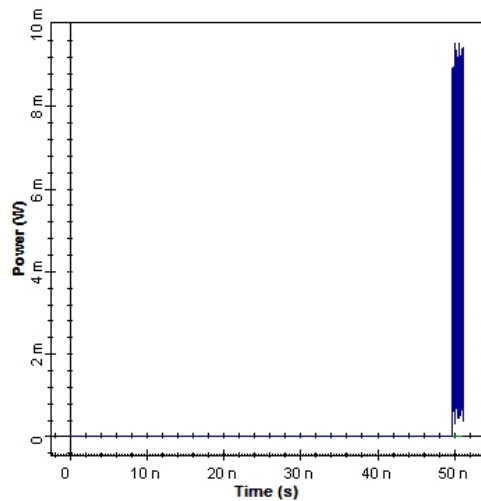

Figure 4.12: Signal transmitted by ONU32 in time domain

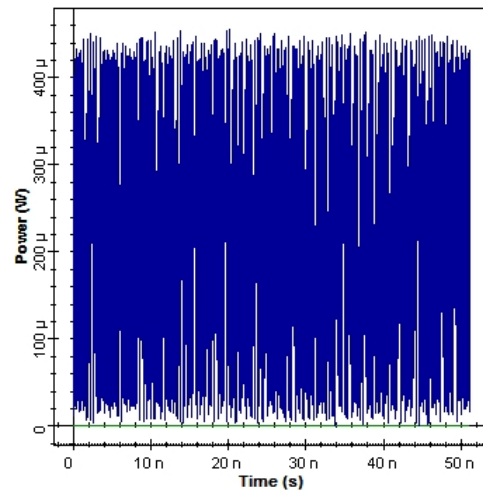

Figure 4.13: Splitter output toward the fiber in the time domain

4.2.2.2 Splitter , Fiber and Circulator

The Bidirectional splitter work as a combiner in the upstream channel. The properties of the splitter was shown in table 3, The output of the splitter toward the fiber in the time domain is shown in figure 4.13.

4.2.2.3 Receiver

Figure 4.14 shows the receiver in the upstream. The only difference between receiver in downstream and upstream is buffer selector in upstream receiver. The first element of the receiver will be the buffer selector, which will be used to select only the latest iteration of the simulation, which will be the one with the correct results. After this element as in the downstream, the signal will pass through the PIN Photodetector where it will be converted to electrical domain and as in other cases will be filtered through BPF. The received signal after photo detection and filtering is illustrated in Figure 4.15. It is clear that the central frequency of the signal is about 5 GHz; also it is clear that there is a power loss and signal distortion due to conversion process in spite of using sampling rate in PD five times of the main sampling rate. The resultant of signal power after the BPF and electrical amplification is about -31.49 dBm, the power losses in BPF is due to the signal cutting. After receiving and filtering the signal, 3R regenerator is used and connected directly to the bit error rate (BER) Analyzer .

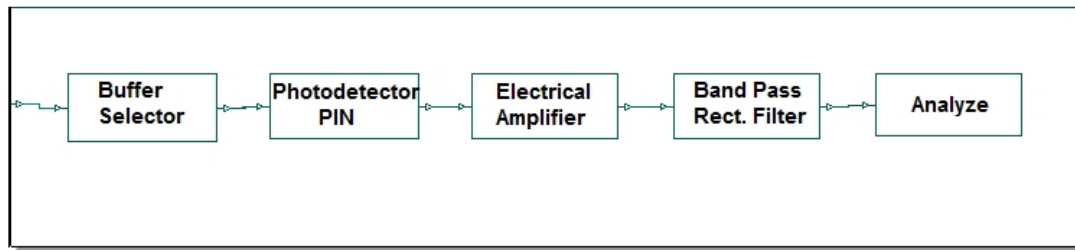

Figure 4.14: Receiver in upstream

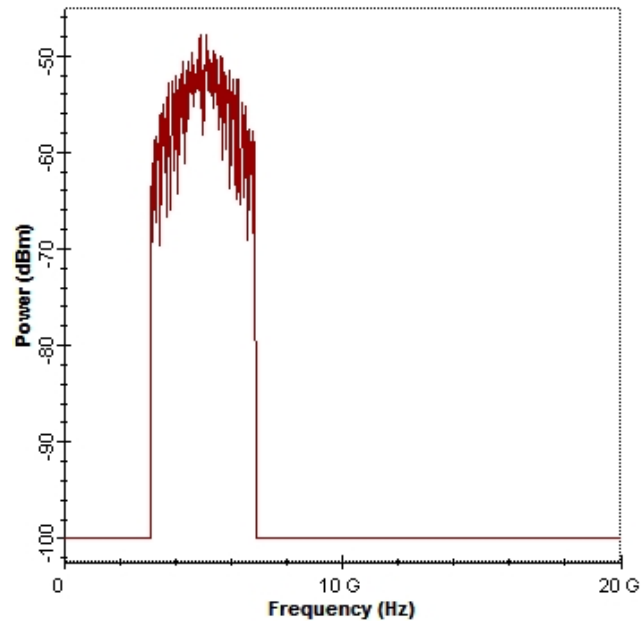

Figure 4.15: received signal after photo detection and filtering

4.3 Results for PSK Modulation for 20 Km Fiber Length

Having explained the whole design, it just needs to get the results that will decide if the design works or not, and therefore whether it will be feasible to implement in a practical case. Hence, the maximum developed physical length from the OLT to ONU in GPON is 20 km [9]. The system will be tested using BPSK Modulation and fiber length of 20 Km and later the system will be tested for fiber length up to 60 km. The results that are going to expose are the eye diagram, the quality factor, the BER and the signal power at the receiver. Let's see first downstream results and later upstream results. The data signal is regenerated at the 5 GHz working frequency for upstream and downstream as shown in Figure 4.16. Figure 4.17 show the Eye diagram and BER of ONU1. all the results of all ONUs "from ONU2 to ONU32" are the same as ONU1 shown. Figure 4.18 presents the eye diagram and BER for the upstream .

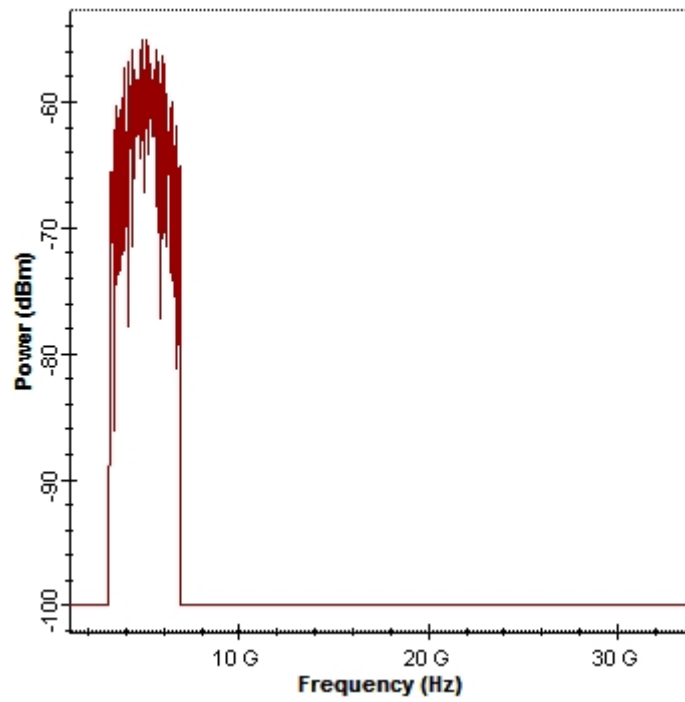

Figure 4.16: RF spectrum regenerated at the 5GHz working frequency

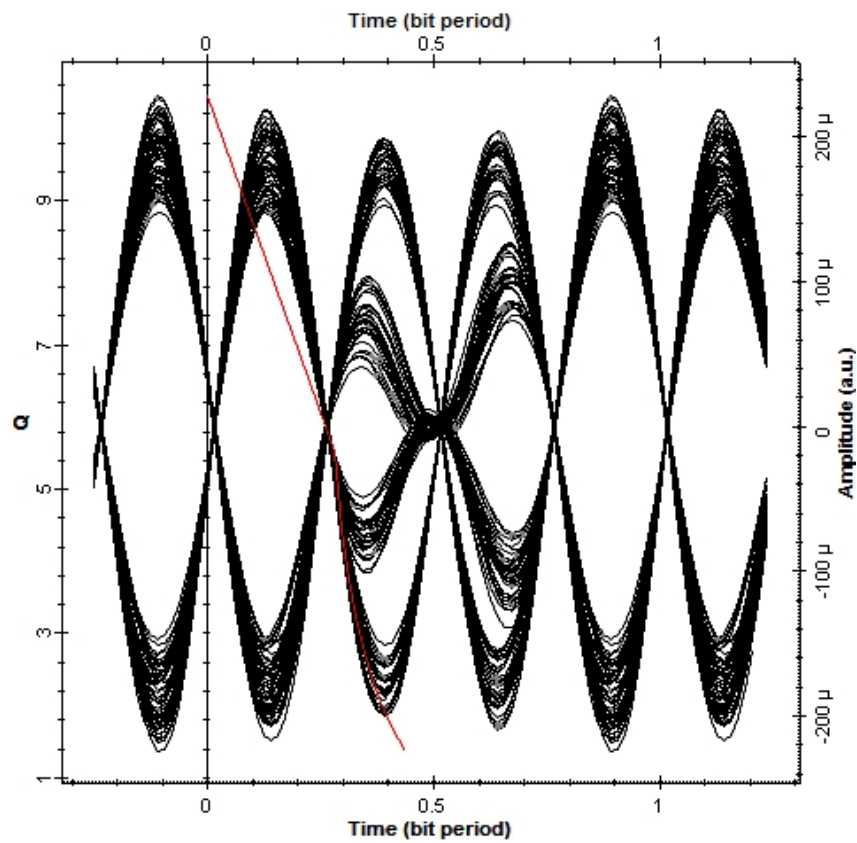

Figure 4.17: Eye diagram and BER of ONU 1 - downstream

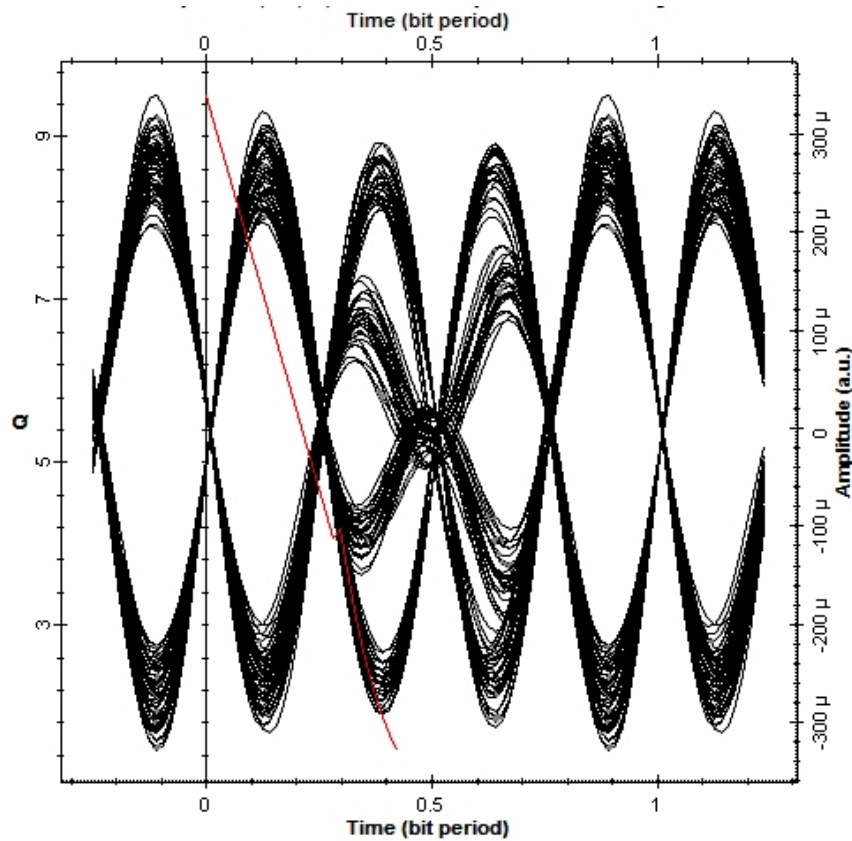

Figure 4.18: Eye diagram and BER for upstream

The received eye diagrams of downstream and upstream signals were measured at ONU and OLT respectively. In both downlink stage and uplink stage, it can be seen that the eye was clear and open and the Q factor has accepted value since it is greater than 6. Table 4.6 compares between two stages, it is clear that the system performs more efficient in the downstream due to using TDMA in upstream.

Table 4.6 PSK Downstream – Upstream results

PSK Parameter	Downlink	uplink
Max Q. Factor	10.50	9.52
Min BER	4.48×10^{-26}	8.24×10^{-22}
Eye Height	1.59×10^{-4}	1.73×10^{-4}
Signal power	-38.76 dBm	-35.50 dBm

The BER is the number of bit errors divided by the total number of transferred bits during a certain time interval. As the BER decreases the system performance increases and it has a range between 0 to 1. The values of BER in downstream and upstream are accepted since it is lower than the standardized minimum 10^{-10} BER for

GPON technology [39].

4.4 Results for DPSK Modulation for 20 Km Fiber Length

The system will be tested for DPSK Modulation and fiber length of 20 Km. The results that are going to expose are the eye diagram, the quality factor, the BER and the signal power at the receiver. The data signal is regenerated at the 5 GHz working frequency as shown in Figure 4.19 for upstream and downstream. Figure 4.20 describes the Eye diagram and BER of ONU1 for downstream. all the results of all ONU's "from ONU 2 to ONU 32" are the same as ONU 1 shown. Figure 4.21 show the Eye diagram and BER for the upstream.

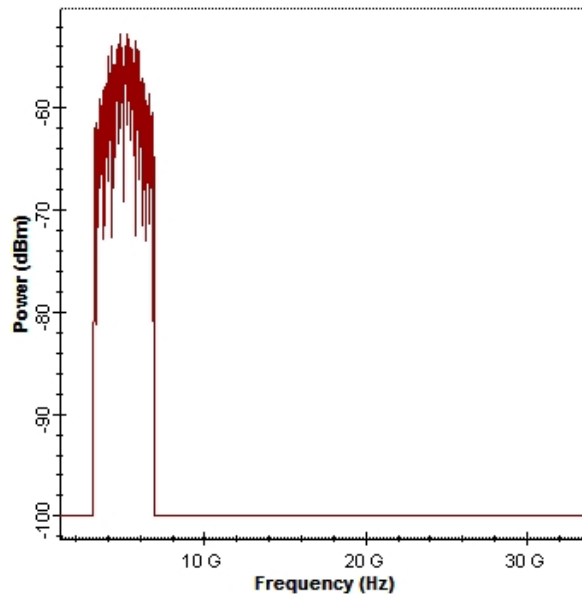

Figure 4.19: RF spectrum regenerated at the 5GHz working frequency

The received eye diagrams of downstream and upstream signals were measured at ONU and OLT respectively. In both downlink stage and uplink stage, it can be seen that the eye was clear and open. Table 4.7 compares between two stages, it is clear that the system performs more efficient in the downstream due to using TDMA in upstream.

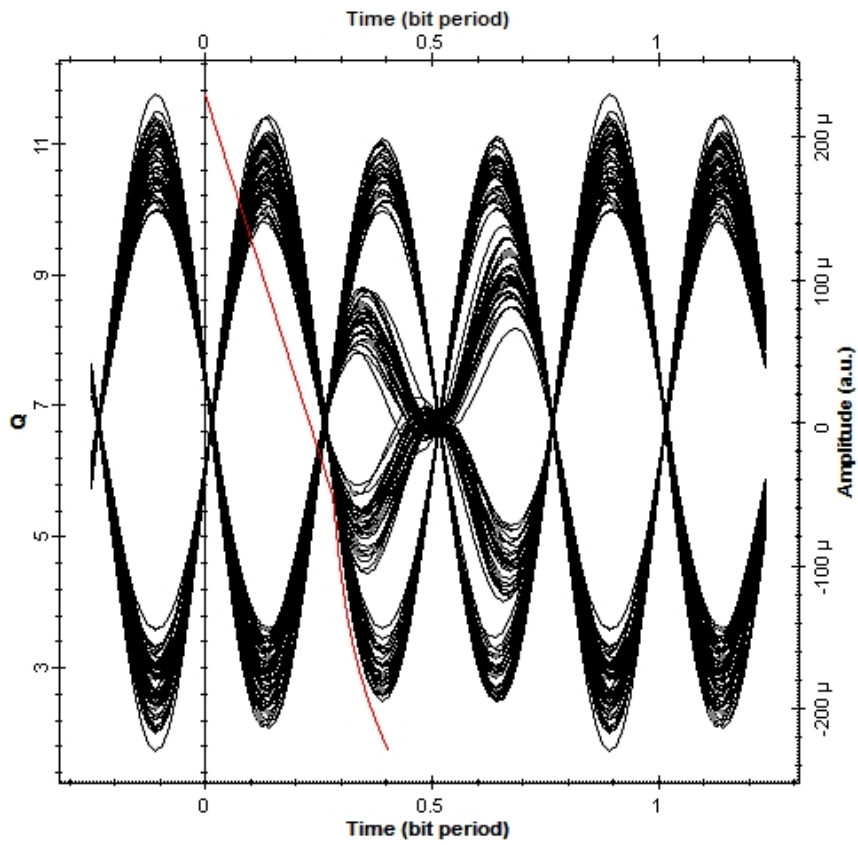

Figure 4.20: DPSK Eye diagram and BER for downstream

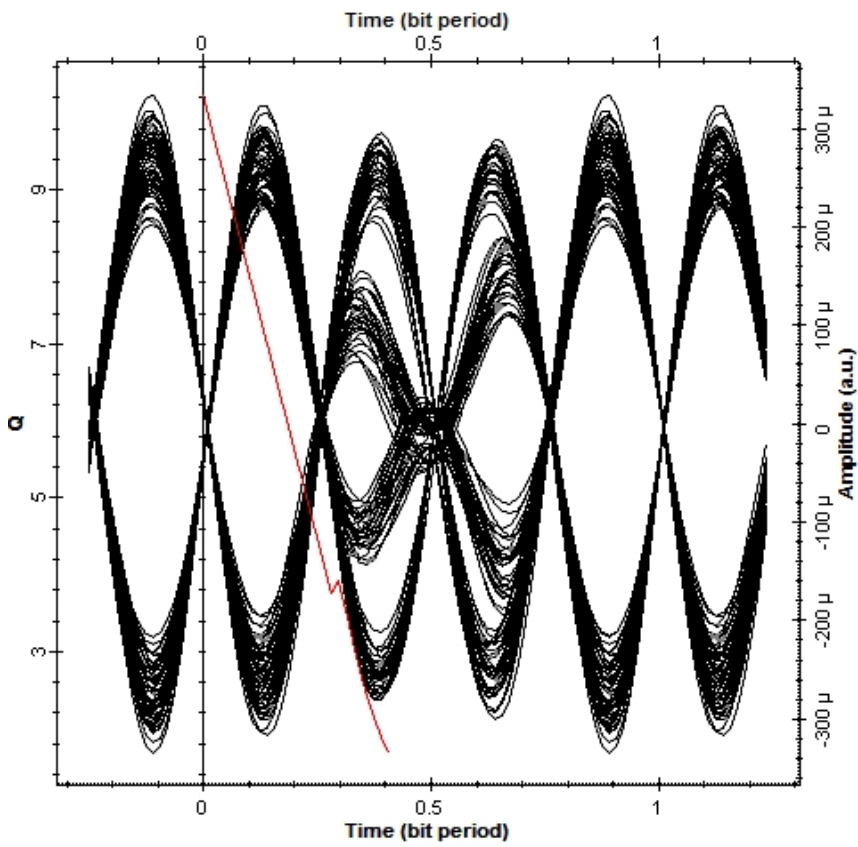

Figure 4.21 : DPSK Eye diagram and BER for upstream

Table 4.7 DPSK downstream – upstream results

DPSK Parameter	Downlink	uplink
Max Q. Factor	10.38	9.51
Min BER	1.49×10^{-25}	9.64×10^{-22}
Eye Height	6.84×10^{-5}	6.98×10^{-5}
Signal power	-46.11 dBm	-42.15 dBm

The results of DPSK modulation is nearly the same as PSK modulation in Eye height and Max Q factor but the results of PSK modulation is better than the results of DPSK modulation in BER and signal power received at the receiver. The values of BER in downstream and upstream are accepted since it is lower than the standardized minimum 10^{-10} BER for GPON technology [39].

4.5 Results for OQPSK Modulation for 20 Km Fiber Length

The system will be tested for OQPSK modulation and fiber length of 20 km. The data signal is regenerated at the 5 GHz working frequency as shown in Figure 4.22 for upstream and downstream. Figure 4.23 shows the Eye diagram and BER of ONU 1 for downstream. all the results of all ONU's "from ONU 2 to ONU 32" are the same as ONU 1 shown. Figure 4.24 shows the Eye diagram and BER for the upstream.

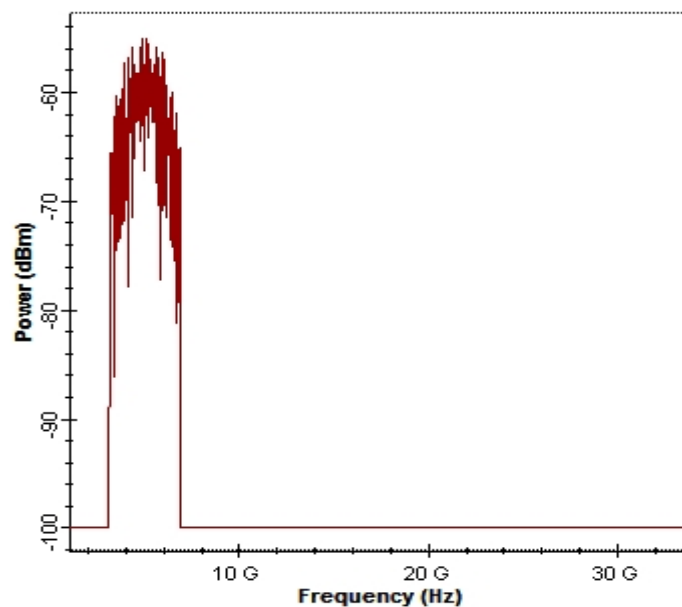

Figure 4.22 : RF spectrum regenerated at the 5GHz working frequency

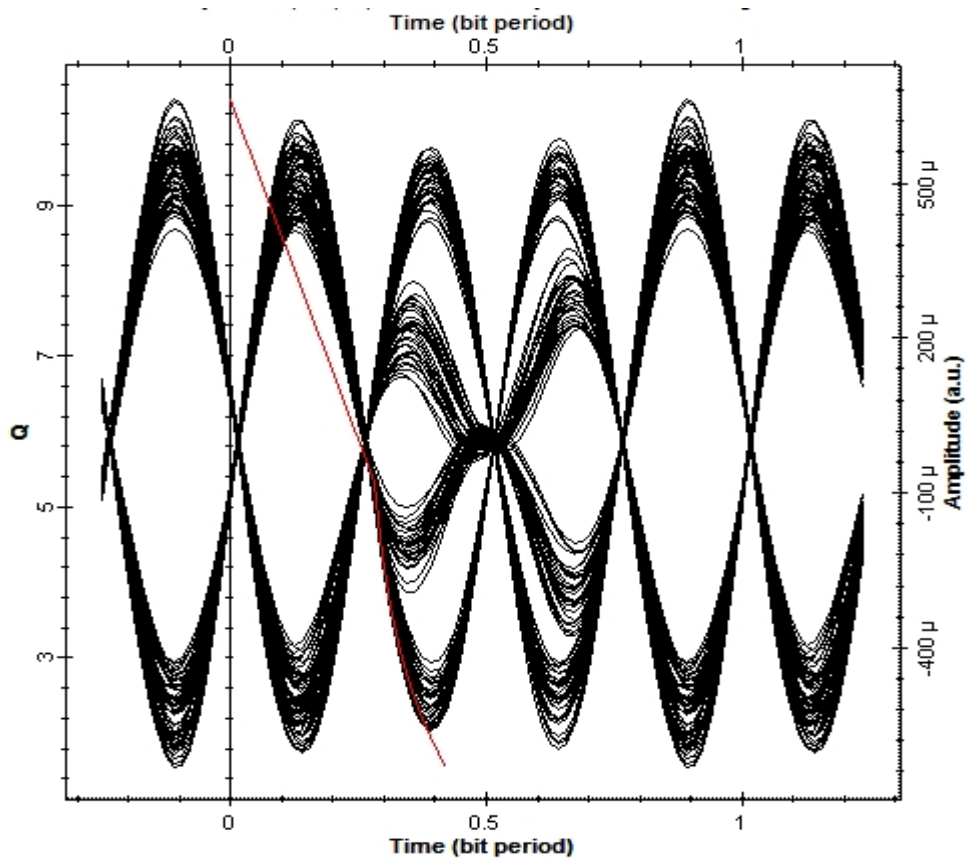

Figure 4.23: OQPSK Eye diagram and BER for downstream

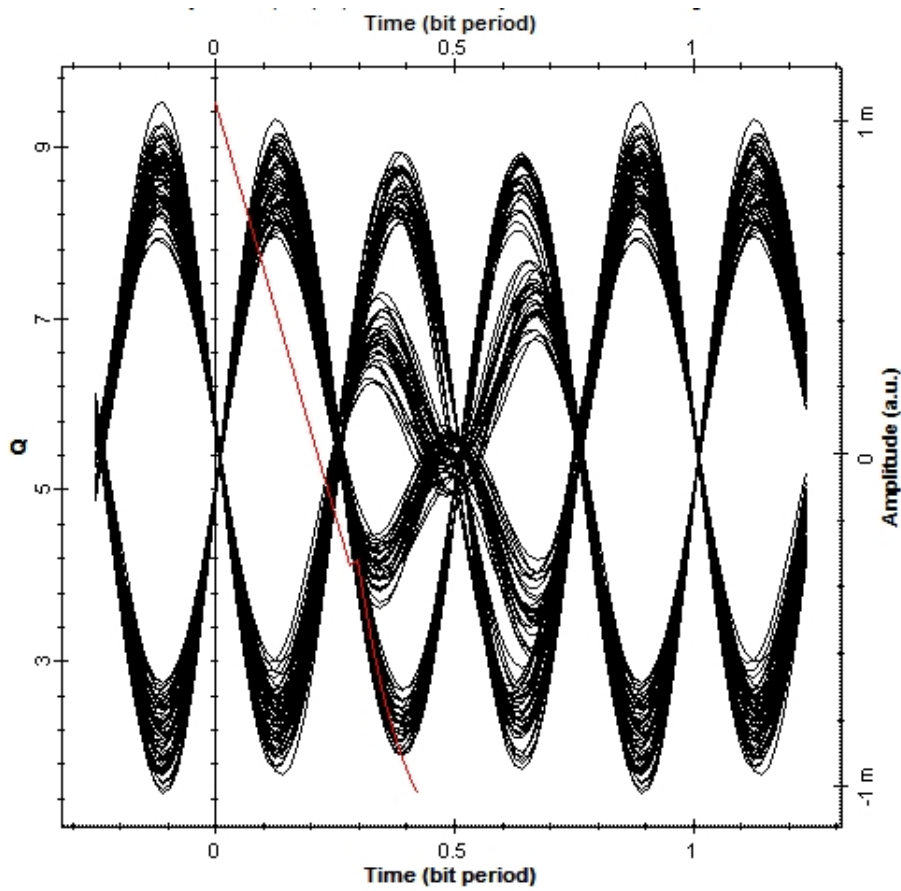

Figure 4.24: OQPSK Eye diagram and BER for upstream

The received eye diagrams of downstream and upstream signals were measured at ONU and OLT respectively. In both downlink stage and uplink stage, it can be seen that the eye was clear and open and the Q factor has accepted value since it is greater than 6. The values of BER in downstream and upstream are accepted since it is lower than the standardized minimum 10^{-10} BER for GPON technology [39]. Table 4.8 compares between two stages, it is clear that the system performs more efficient in the downstream due to losses in TDMA in upstream.

Table 4.8 OQPSK Downstream – Upstream results

PSK Parameter	Downlink	uplink
Max Q. Factor	10.40	9.51
Min BER	1.21×10^{-25}	9.07×10^{-22}
Eye Height	1.4×10^{-4}	1.70×10^{-4}
Signal power	-39.66 dBm	-35.64 dBm

4.6 Test the performance of the PSK, DPSK and OQPSK System for different Fiber length

At this section the performance of the system will be evaluated for PSK, DPSK and OQPSK with a fiber length from 10 km up to 60 Km. Figure 4.25 shows the BER for downstream and upstream of the system with PSK modulation for length of fiber from 10km up to 60 km

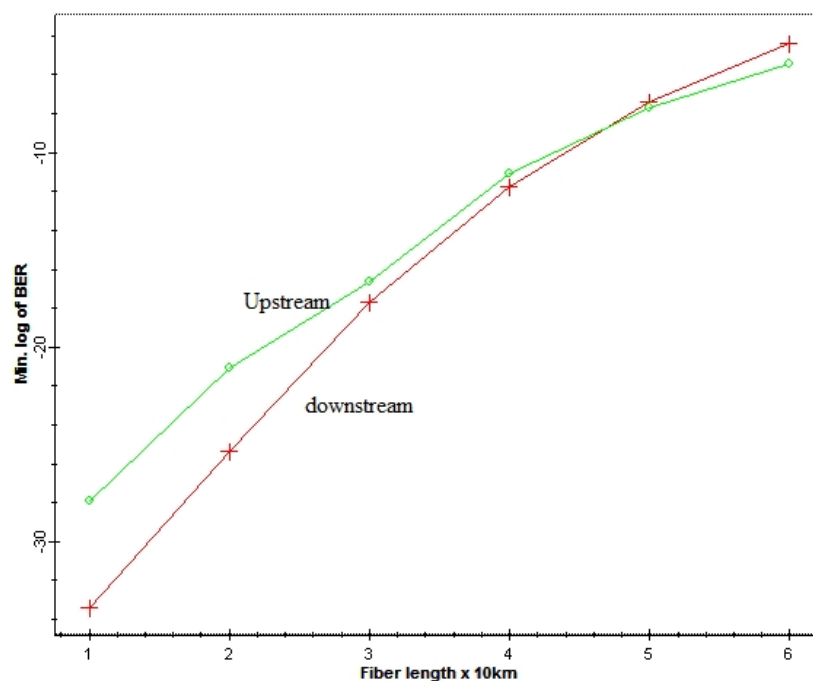

Figure 4.25: BER of PSK for system of varied fiber length

It can be seen in Figure 4.25 that BER increases with fiber length increases. The performance of downstream is better than upstream of fiber length up to 47km. The upstream signal appears to be better for fiber length from 50 km up to 60 km but it located under 10^{-10} line and not accepted for optical communication. Figure 4.26 show the signal power at the receiver for downstream and upstream of the system with PSK modulation for length of fiber from 10km to 60 km.

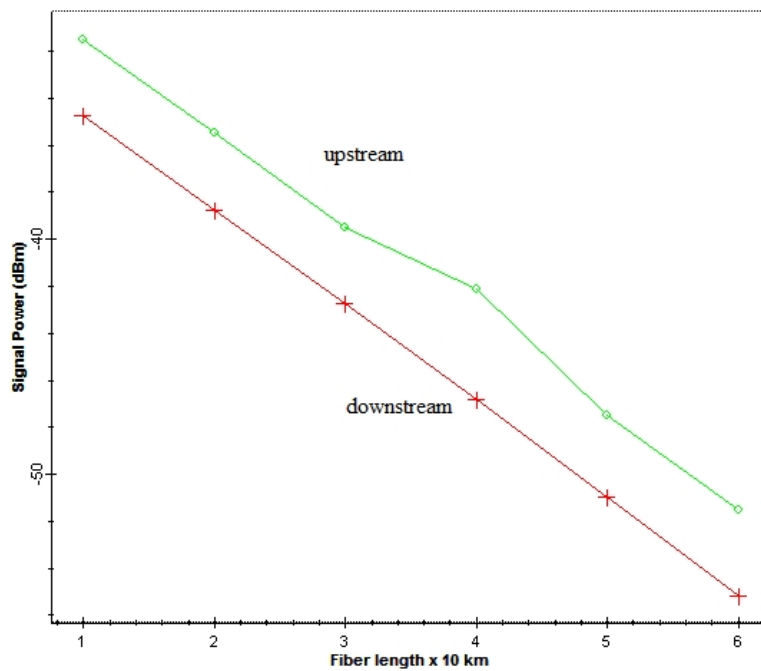

Figure 4.26: Received Power for PSK system of varied fiber length

It is clear that the signal power received at the receiver decreases with as the fiber length increase. Figure 4.27 show the BER for downstream and upstream of the system with DPSK modulation for length of fiber from 10km up to 60 km.

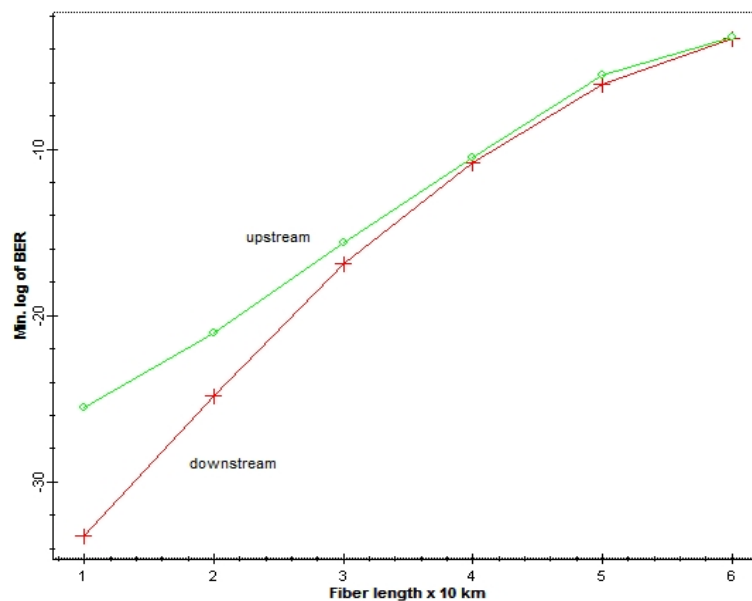

Figure 4.27 BER of DPSK for system of varied fiber length

It can be seen in Figure 4.27 that BER increases with fiber length increases. Figure 4.28 shows the total power at the receiver for downstream and upstream of the system with DPSK modulation for length of fiber from 10km up to 60 km. The signal power received at the receiver decreases as the fiber length increase as shown in figure 4.28

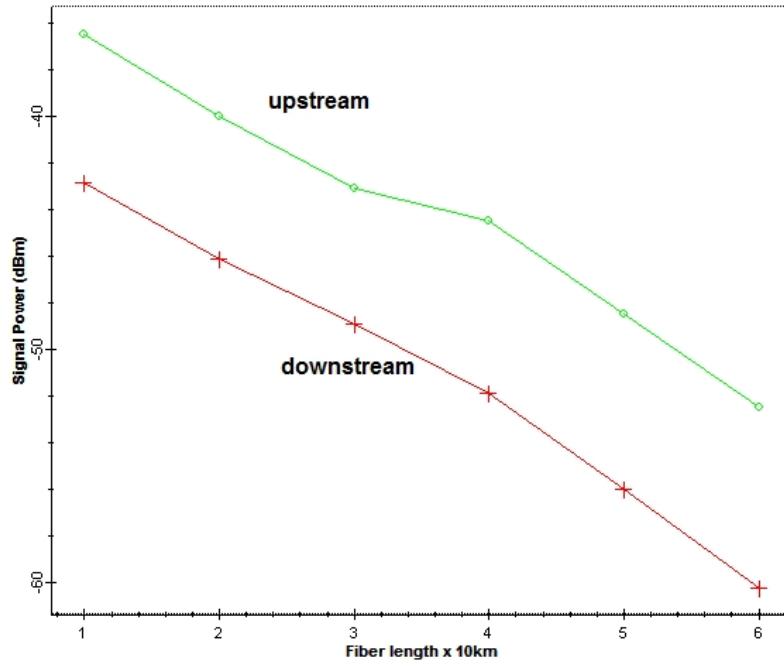

Figure 4.28: Received Power for DPSK system of varied fiber length

Figure 4.29 show the BER for downstream and upstream of the system with OQPSK modulation for length of fiber from 10km up to 60 km.

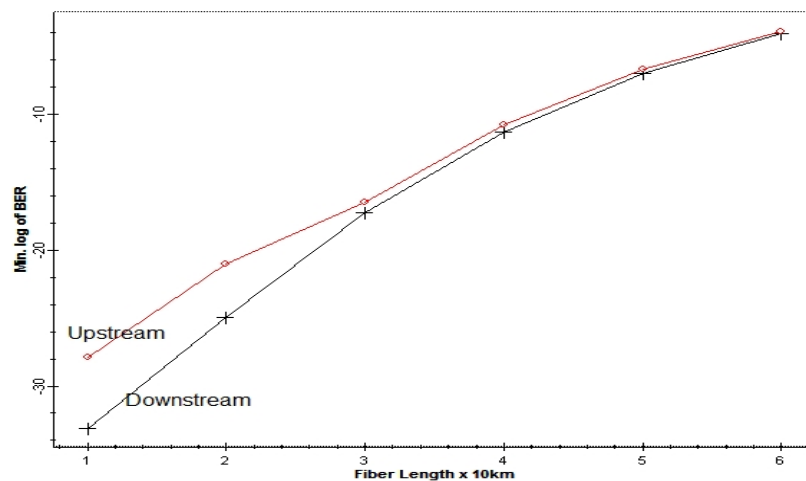

Figure 4.29: BER of OQPSK for system of varied fiber length

It is clear that BER increases with fiber length increases. Figure 4.30 shows the signal power at the receiver for downstream and upstream of the system with OQPSK modulation for length of fiber from 10km up to 60 km. The signal power received at the receiver decreases as the fiber length increases as shown in figure 4.30.

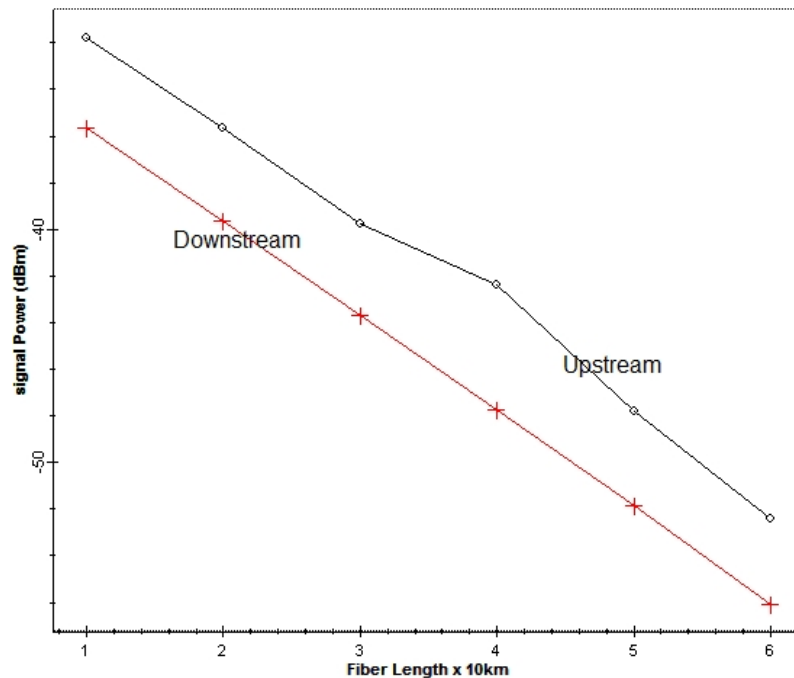

Figure 4.30: Received Power for OQPSK system of varied fiber length

4.7 Results comparison of various modulation type and fiber length

Figure 4.31 shows the downstream BER for different modulation schemes and different fiber lengths. As it can be seen that the BER of the PSK modulation is better than DPSK and OQPSK modulation in the downstream, and the BER is accepted for length of fiber up to 40 km, at this distance, the PSK BER= 1.6×10^{-12} , DPSK BER= 1.6×10^{-11} and OQPSK BER= 5.11×10^{-12} . At fiber length of 50 km, 60 km the BER is under the 10^{-10} line and not accepted for GPON network. Figure 4.32 show the upstream BER for PSK, DPSK and QPPSK modulation for length of fiber from 10km to 60 km. As it can be seen that the BER of the PSK modulation is better than DPSK and OQPSK modulation in the upstream. The BER is accepted for different modulation schemes and length of fiber up to 40 km, at this distance, the PSK BER= 8.3×10^{-12} , DPSK BER= 3.4×10^{-11} and OQPSK BER= 1.6×10^{-11} . At fiber length of 50 km, 60 km the BER is under the 10^{-10} line and not accepted for GPON network.

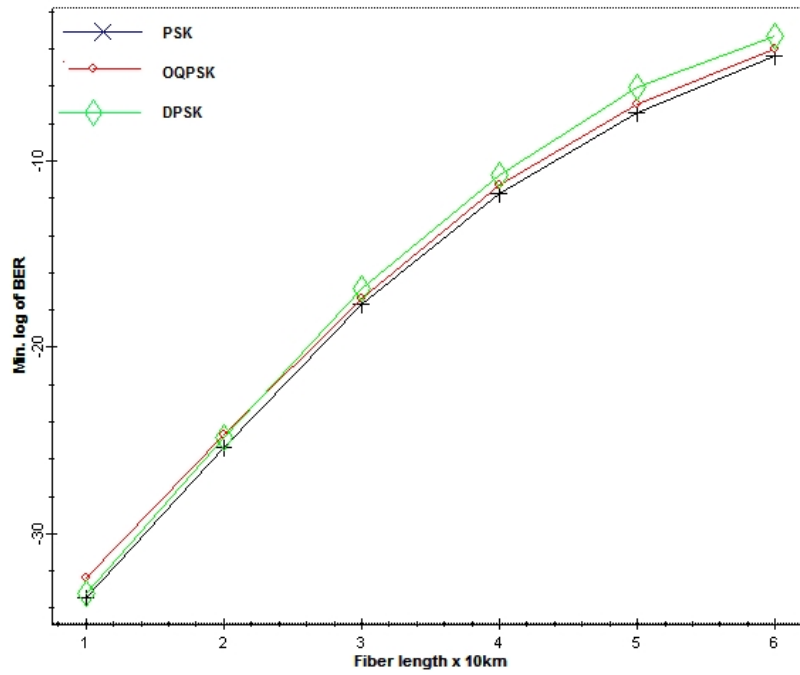

Figure 4.31: downstream BER for PSK, OQPSK and DPSK and for varied fiber length

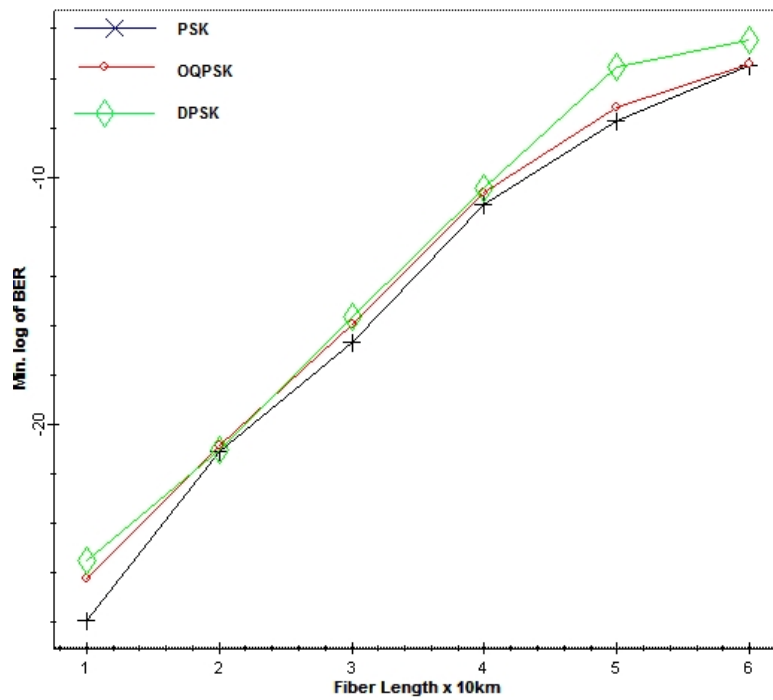

Figure 4.32 Upstream BER for PSK, OQPSK and DPSK and for varied fiber length

The results from the received signal spectrum and eye diagram presented in previous sections are given in tabular form table 4.9, for different modulation schemes and fiber length.

Table 4.9 Results comparison for various modulation type and fiber link

	DOWNSTREAM			UPSTREAM		
	BER	Eye height	Power	BER	Eye height	Power
PSK 10km	3.9×10^{-34}	2.6×10^{-4}	-34.8dB	1.2×10^{-28}	3.1×10^{-4}	-31.5dB
PSK 20km	4.5×10^{-26}	1.6×10^{-4}	-38.7dB	8.2×10^{-22}	1.7×10^{-4}	-35.5dB
PSK 30km	1.9×10^{-18}	9.2×10^{-5}	-42.7dB	2.1×10^{-17}	9.5×10^{-5}	-39.5dB
PSK 40km	1.6×10^{-12}	5.0×10^{-5}	-46.8dB	8.3×10^{-12}	8.9×10^{-5}	-43.5dB
PSK 50km	3.8×10^{-8}	2.4×10^{-5}	-50.9dB	2.0×10^{-8}	4.6×10^{-5}	-47.5dB
PSK 60km	4.2×10^{-5}	7.9×10^{-6}	-55.2dB	3.5×10^{-6}	2.8×10^{-5}	-51.5dB
DPSK 10km	6.3×10^{-34}	1.1×10^{-4}	-42.8dB	2.9×10^{-26}	1.7×10^{-4}	-36.5dB
DPSK 20km	1.5×10^{-25}	6.9×10^{-5}	-46.1dB	9.6×10^{-22}	7.0×10^{-5}	-42.1dB
DPSK 30km	1.4×10^{-17}	4.5×10^{-5}	-48.9dB	2.3×10^{-16}	8.1×10^{-5}	-43.1dB
DPSK 40km	1.6×10^{-11}	2.7×10^{-5}	-51.8dB	3.4×10^{-11}	6.4×10^{-5}	-44.4dB
DPSK 50km	8.3×10^{-7}	1.2×10^{-5}	-56dB	3.6×10^{-5}	3.6×10^{-5}	-48.4dB
DPSK 60km	4.6×10^{-4}	1.8×10^{-6}	-60.2dB	1.9×10^{-5}	1.9×10^{-6}	-52.4dB
OQPSK 10km	8.2×10^{-34}	2.3×10^{-4}	-35.6dB	1.2×10^{-28}	3.0×10^{-4}	-31.8dB
OQPSK 20km	1.2×10^{-25}	4.4×10^{-5}	-39.6dB	9.7×10^{-22}	1.7×10^{-4}	-35.6dB
OQPSK 30km	5.9×10^{-18}	8.2×10^{-5}	-43.6dB	3.4×10^{-17}	9.1×10^{-5}	-39.8dB
OQPSK 40km	5.2×10^{-12}	4.4×10^{-5}	-47.7dB	1.6×10^{-11}	8.6×10^{-5}	-42.9dB
OQPSK 50km	1.1×10^{-7}	2.1×10^{-5}	-51.87dB	2.2×10^{-7}	3.6×10^{-5}	-46.4dB
OQPSK 60km	9.3×10^{-5}	5.9×10^{-6}	-56.1dB	1.1×10^{-5}	6.7×10^{-6}	-53.4dB

4.7 Summary

The RoF employed GPON system was tested for different modulation schemes. Firstly, the system was tested for 20 km fiber length and different modulation schemes. The received eye diagrams of downstream and upstream signals were measured at ONUs and OLT respectively. In both downlink stage and uplink stage, the eye was clear and open, BER and Signal power values were accepted for different modulation schemes. Secondly, the system was tested for different modulation schemes and fiber length from 10 Km up to 60 Km and a comparison was made. In downstream and upstream , increasing the fiber length, the BER increases and the signal power decreases.

BER is accepted for length of fiber up to 40 km in upstream and downstream for different modulation schemes. BER results of the PSK modulation is better than DPSK and OQPSK modulation in the downstream and the upstream.

5. Conclusion and Future Work

5.1 Summary

RoF is a very effective technology for integrating wireless and optical access. It combines the two media; fiber optics and radio, and it is a way to easily distribute radio frequency as a broadband or baseband signal over fiber. It utilizes analog fiber optic links to transmit and distribute radio signals between a central CS and numerous BSs. In this sense RoF is a promising technology for future high-capacity and broadband multimedia wireless services.

GPON has gained much interest in today's networking due to the flexibility, simple and low cost passive connection. For instance, GPON technology has been successfully deployed in Fiber-to-the-Home (FTTH) that support Triple-Play services which combine the internet data, telephony and video to the home through only single cable. This research provides characterization of RoF employed GPON architecture for wireless distribution network.

The Simulation was performed on OPTISYSTEM software. The analysis of simulation results were based on received signal strength and eye pattern obtained for various modulation schemes. The system was analyzed using PSK modulation and DPSK Modulation. The system was tested for length from the OLT to ONU of from 10km up to 60Km. In the design of the proposed system, one transmitter and one receiver were used at OLT and distributed to the 32 ONUs. Bidirectional fiber was used with length up to 60 km. A bidirectional 1:32 passive optical splitter was used to connect the ONU's to the backbone fiber. The upstream and downstream signal separated by the optical circulator and optical delay introduced at the fiber to ensure the correct timing of circulation. The bit rate of the downstream and upstream was set at 2.5 Gbps and the chosen working frequency was 5 GHz which operated as IEEE 802.11a signal. The optical modulation that consisted of CW LD and MZM which worked at 1490 nm for downstream and 1330 nm for upstream.

In the first part at this work, the system was tested for BPSK modulation, with fiber length of 20 Km. The received eye diagrams of downstream and upstream signals were measured at ONUs and OLT respectively. In both downlink stage and uplink stage, it can be seen that the eye was clear and open. BER and Signal power values were accepted without using optical amplifier.

In the second part at this work, the system was tested for DPSK modulation, with fiber length of 20 Km. Both eye diagram and BER values were accepted. And in the third part the system was tested for OQPSK modulation with 20km fiber length and accepted results were achieved.

Finally, the system was tested for different modulation schemes and different fiber lengths, and a comparison was made. In downstream and upstream, increasing the fiber length, the BER increases and the signal power decreases. BER of the PSK modulation is better than DPSK and OQPSK modulation in the downstream and the upstream. The BER is accepted for length of fiber up to 40 km for different modulation schemes in both downstream and upstream, at this distance the value of BER is not exceed the accepted value for GPON which is 10^{-10} . The value of BER is not accepted for fiber length more than 40 Km since it exceed the limit 10^{-10} . with high bandwidth, flexible and simple assessment.

RoF and GPON technology is indeed a promising solution for today's communication to support the continuous increasing figure of wireless internet users. BPSK is the most appropriate modulation scheme. It gives maximum power, and minimum bit error rate (BER) for satisfactory receiver performance.

5.2 Suggestion for Improvement

The design in this work can be upgraded to give better performance. To increase the system efficiency, the data rate and the number of optical network unit can be increased. We use a 1:32 Splitter to serve 32 ONU, we can increase this to 64 ONU. Also At this design we use three type of modulation PSK, DPSK and OQPSK, the design can be modified to operate with other modulation techniques such as quadrature amplitude modulation QAM. The concept of wavelength division multiplexing (WDM) can be applied as future recommendations to efficiently utilize the available

BW resources.

References

- [1] A. Zin, S. Idrus, and N. Zulkifli³, "Performance of IEEE 802.11 over Fiber at MAC Layer Employing GPON Architecture" IEEE 2nd International Conference on Digital Object Identifier, 2011.
- [2] A. Zin, S. Idrus, N. Zulkifli, "The Characterization of Radio-over-Fiber Employed GPON Architecture for Wireless Distribution Network", International Journal of Machine Learning and Computing, vol. 1, no. 5, pp. 522-527, 2011.
- [3] H. Al-Raweshidy and S. Komaki, Radio over fiber technologies for mobile communications networks: Artech House, 2002.
- [4] M. Bonilla, F. Barbosa, and E. Moschim, "Techno-Economical Comparison Between GPON and EPON Networks", Proceeding of ITU-T Kaleidoscope Academic Conference, 2009 .
- [5] S. Lallukka and P. Raatikainen, "Link Utilization and Comparison of EPON and GPON Access Network Cost", Proceeding of IEEE Globecom, vol. 1, pp. 301-305, 2005.
- [6] I. Cale, A. Salihovic and M. Ivekovic, "Gigabit Passive Optical Network GPON" Proceedings of the ITI 2007 29th Int. Conf. on Information Technology Interfaces, pp. 679-684, 2007 .
- [7] ITU-T Recommendation G.984.1, "Gigabit-capables passive optical network (GPON)", ITU, 2008.
- [8] H. Bras, and M. Moignard, "Distribution of 3G Base Stations on Passive Optical Network Architecture", Microwave Photonics, International Topical Meeting, 2006.
- [9] G. Shen, "Fixed Mobile Convergence Architectures for Broadband Access: Integration of EPON and WiMAX", IEEE Communication Magazine, Volume: 45 , no. 8, pp. 44-50, 2007.

- [10] H. Bakarman, S. Shaari and M. Ismail, "Simulation of 1.25 Gb/s Downstream Transmission Performance of GPON-FTTx", IEEE International Conference on Digital Object Identifier, 2010 .
- [11] G. Keiser, Optical Fiber Communications: McGraw-Hill,2000.
- [12] H. Sasai, T. Niiho, K. Tanaka, K. Utsumi and S. Morikura , "Radio-over-fiber transmission performance of OFDM signal for dual-band wireless LAN systems", IEEE Microwave Photonics, pp. 139-142, 2003.
- [13] G. Agrawal, Fiber-optic communication systems: Wiley, 2012.
- [14] H. Bulow, "System outage probability due to first and second order PMD," IEEE Photonics Technology Letters, vol. 10, no. 5, pp. 696-698, 1998.
- [15] G. Sasaki, K. Sivarajan and R. Ramaswami, Optical Networks A Practical Perspective: Third Edition, ELSEVIER, 2010.
- [16] P. Thijs, L. Tiemeijer, P. Kuindersma, J. Binsma, and T. Dongen, "High Performance 1.5m Wavelength InGaAs-InGaAsP Strained Quantum Well Lasers and Amplifiers", IEEE J. of Quantum Electron, vol. 27, no. 6, pp. 1426-1439, 1991.
- [17] E. Ackerman and C. Cox, "RF fiber-optic link performance", Microwave Magazine, IEEE, vol.2, no. 4, pp. 50-58, 2001.
- [18] E. Desurvire, Erbium Doped Fibre Amplifiers, New York, USA: Wiley, 1994.
- [19] R. Laming, M. Zervas, and D. Payne, "Erbium doped amplifier with 54dB gain and 3.1dB noise figure", IEEE Photon. Technol. Lett, vol. 4, no. 12, pp. 1345-1347, 1992.
- [20] J. Nilsson, S. Yun, S. Hwang, J. Kim, and S. Kim, "Long wavelength erbium-doped fibre amplifier gain enhanced by ASE end reflectors," IEEE Photon. Technol. Lett, vol. 10, no. 11, pp. 1551-1553, 1998.

- [21] T. Whitley, R. Wyatt, D. Szebesta, and S. Davey, "Towards a practical 1.3 μ m optical fibre amplifier", BT Technol. J, 1993.
- [22] j. McGeough, Semiconductor Optical Amplifiers to Extend the Reach of Passive Optical Networks: University of Glasgow, 2012.
- [23] G. Keiser, FTTX concepts and applications: John Wiley & Sons, 2006
- [24] ITU-T G.984.1 "Gigabit-capable Passive Optical Networks (GPON): General characteristics", ITU 2003.
- [25] B. Dang and I. Niemegeers "Analysis of IEEE 802.11 in Radio over Fiber Home Networks" Proceedings of the IEEE Conference on Local Computer Networks, pp. 744-747, 2005.
- [26] A. Cooper, "Fiber/Radio for the provision of cordless/mobile telephony services in the access network", Electron. Lett, vol. 26, pp. 2054-2056, 1990.
- [27] M. Webster, G. Wimpenny, K. Beacham and L. Crawford, "Radio over fiber for mobile communications," IEEE, pp.157-160, 2004.
- [28]. D. Novak, "Fiber Optics in Wireless Applications", OFC 2004 Short Course 217, 2004.
- [29]. J. O'Reilly, P. Lane, and M. Capstick, "Optical Generation and Delivery of Modulated mm-waves for Mobile Communications", Analog Optical Fiber Communications, IEE, pp. 229-256, 1995.
- [30]. Y. Koike, "POF Technology for the 21st Century", in Proceedings of the Plastic Optical Fibres (POF) Conference, 2001.
- [31]. Y. Watanabe, "Current Status of Perfluorinated GI-POF and 2.5 Gbps Data Transmission over it", in Proceedings of OFC, vol. 1, no. 12, 2003.

- [32]. D. Wake, and K. Beachman, "A Novel Switched Fibre Distributed Antenna System", in Proceedings of European Conference on Optical Communications, vol. 1, pp. 55-56, 2004.
- [33]. D. Mynbaev, L. Scheiner, Fiber Optic Communications Technology: Prentice Hall, New Jersey, 2001.
- [34]. A. Ng'oma, "Radio-over-fiber technology for broadband wireless communication systems," Eindhoven, The Netherlands, PhD Thesis, 2005.
- [35] A. Kim, Y. Joo and Y. Kim, "60 GHz wireless communication systems with radio-over-fiber links for indoor wireless LANs", Consumer Electronics, IEEE Transactions on, vol. 50, no. 2, pp. 517-520, 2004.
- [36] L. Couch, Digital and Analog Communications: 6th ed. Upper Saddle River, USA: Prentice-Hall, 1997.
- [37] J. Proakis, Digital Communications: Third Edition. Singapore: McGraw Hill, 1995.
- [38] U. Madhow, Fundamentals of Digital Communication: Cambridge University Press, 2008.
- [39] S. Pato, J. Santos, J. Pedro, P. Monteiro and H. Silva, "On Supporting Radio over Fiber and Passive Optical Network Systems with a Common Fiber Plant Compatibility Aspects", Proceeding of ITCON, vol. 2, pp. 203-206, 2008.
- [40] D. Mynbaev and L. Scheiner, Fiber Optic Communications Technology: Prentice Hall, New Jersey, 2001.
- [41] O. Company, "Broadband Optical System Based on a Passive Optical Network (BPON)". Retrieved 22, 2014, from optiwave, 2010.
<http://optiwave.com/resources/applications-resources/optical-system-broadband-optical-system-based-on-a-passive-optical-network-bpon/#>